

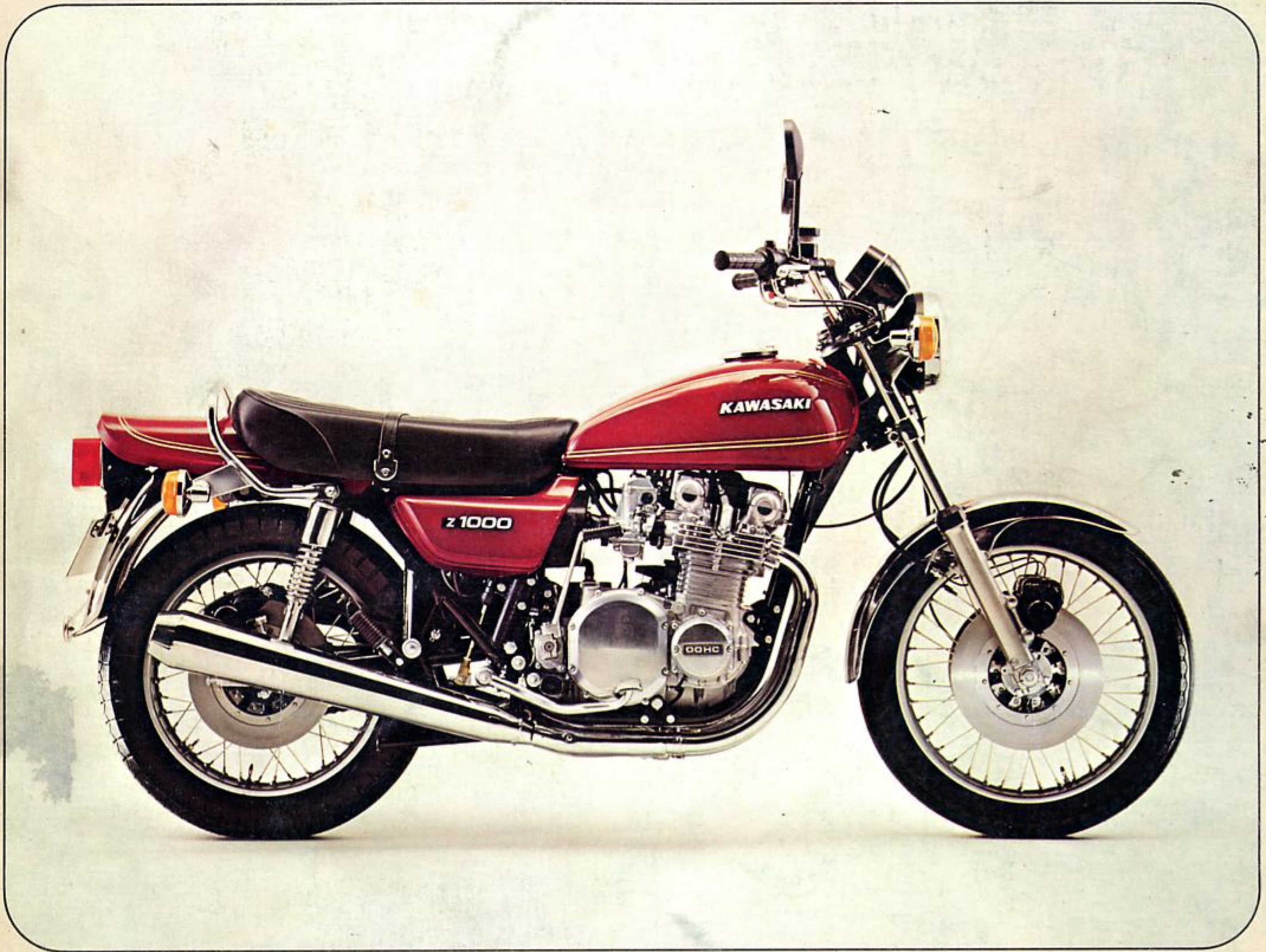

**Kawasaki**

**Z1000-A1**



**MOTORCYCLE**

**ASSEMBLY & PREPARATION  
MANUAL**



## NOTICE TO DEALERS

This manual is provided to insure that the motorcycle is assembled correctly and given proper presale preparation. Your customer expects and deserves a safe, reliable motorcycle, and performance of the steps listed here is essential to that end.

The selling dealer assumes sole responsibility for any unauthorized modifications prior to sale. Refer to your Service Binder for any Service Bulletins specifying Factory Directed Modifications (Special Claims) which must be performed before the motorcycle is ready for sale.

Whenever you see the symbols shown below, heed their instructions! Always follow safe operating and maintenance practices.

**WARNING** This warning symbol identifies special instructions or procedures which, if not correctly followed, could result in personal injury, or loss of life.

**CAUTION** This caution symbol identifies special instructions or procedures which, if not strictly observed, could result in damage to, or destruction of equipment.

"NOTE" indicates points of particular interest for more efficient and convenient operation.





**Z1000-A1**



# **MOTORCYCLE ASSEMBLY & PREPARATION MANUAL**

## **TABLE OF CONTENTS**

MODEL IDENTIFICATION.....	2
ASSEMBLY INSTRUCTIONS.....	3
PREPARATION INSTRUCTIONS.....	11
APPENDIX	
SPECIFICATIONS.....	19
CHECK AND TIGHTEN.....	20
TEST RIDE.....	23
WIRING DIAGRAM.....	24



# Model Identification



BEGINNING

Engine No. KZT00AE000101

Frame No. KZT00A-000101



# Assembly

## UNCRATING

Place the shipping crate in a large, cleared work area. Open the crate using a pry bar. With assistants, move the unit to the set-up area.

**CAUTION** Bend over all exposed nails to prevent injury or possible machine damage.

Collect the front wheel, front fender, and parts boxes. Be careful to remove the parts stored in the cavities in the styrofoam. Open the parts boxes and check for shipping damage or missing parts.

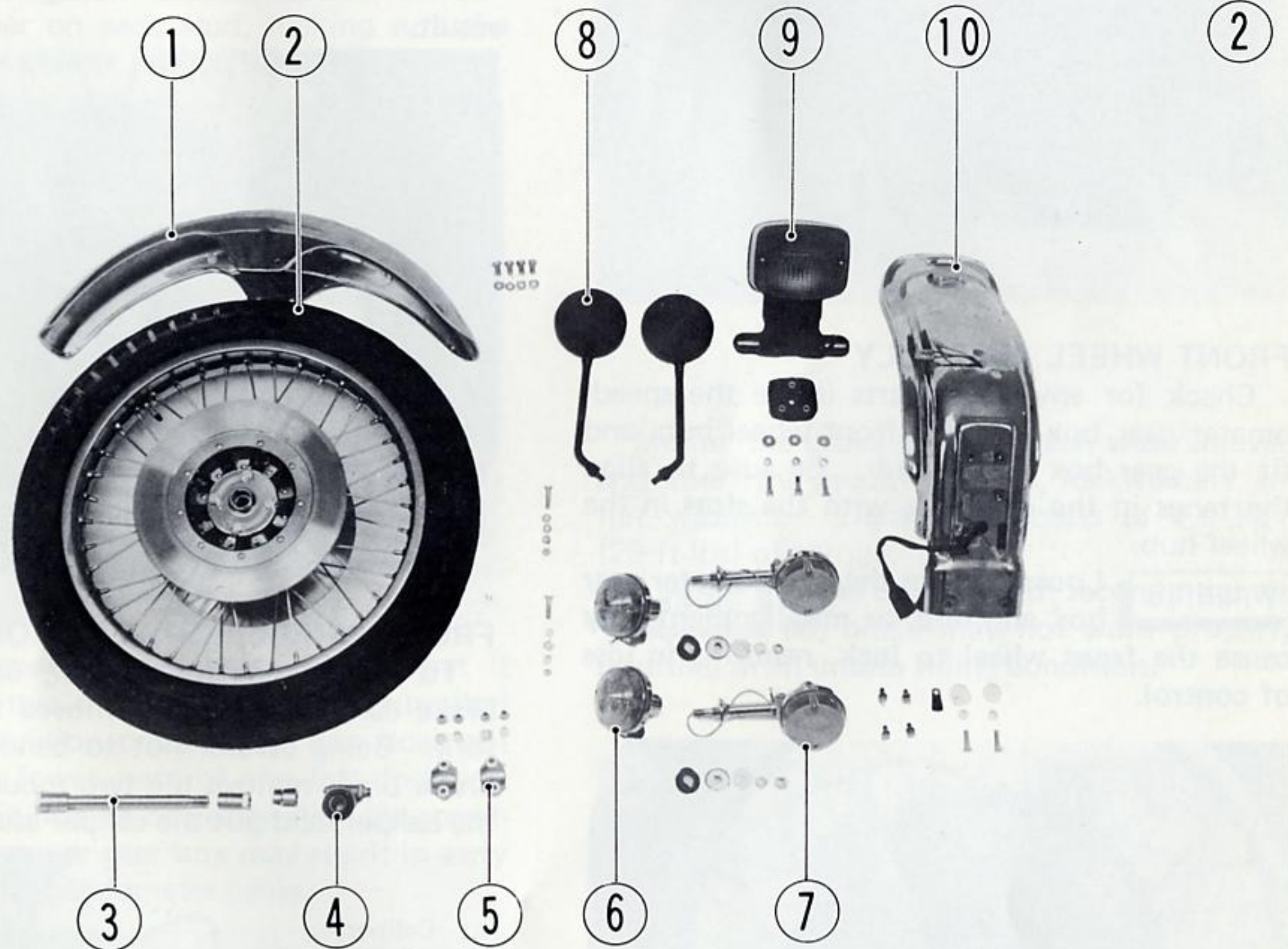
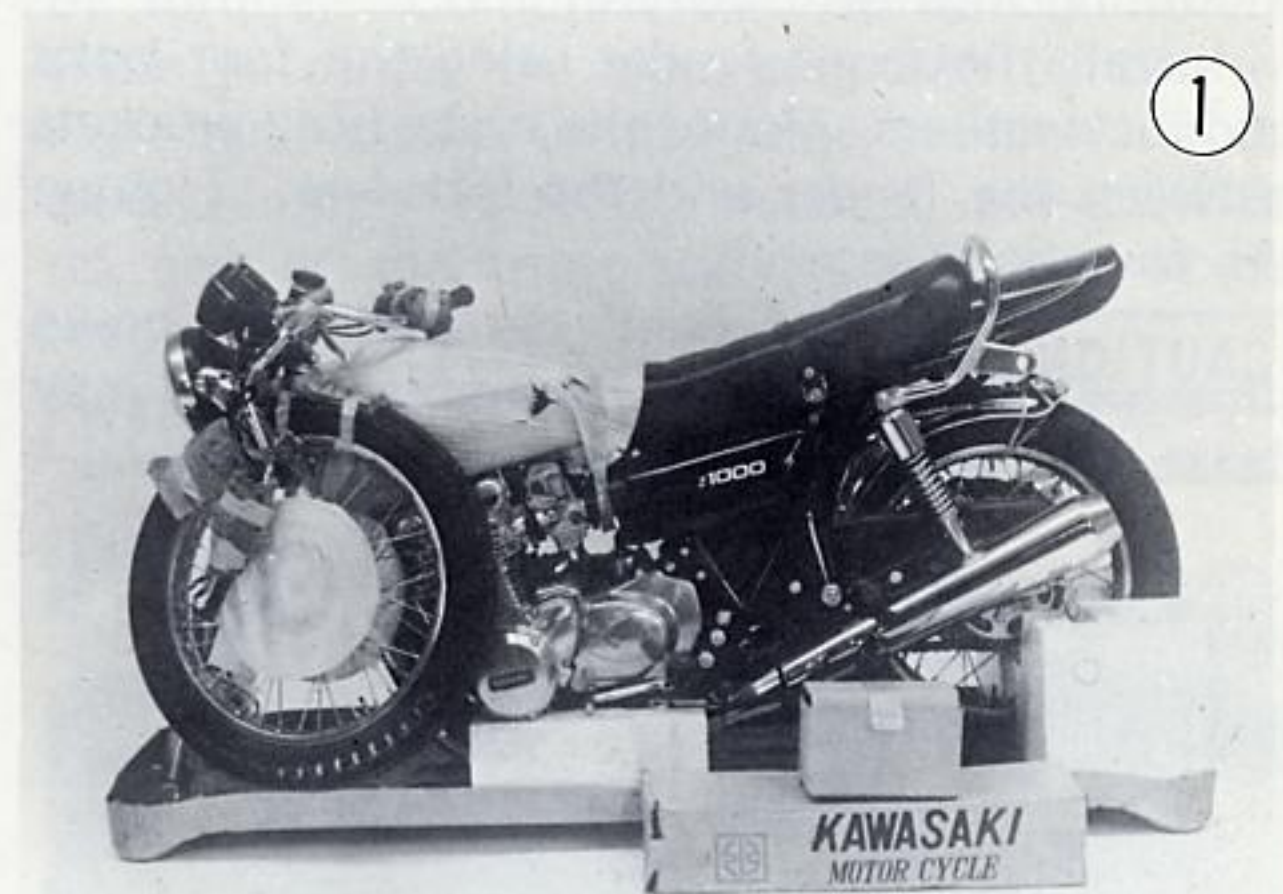

1. Front fender, with four bolts and lockwashers
2. Front wheel assembly
3. Front axle
4. Speedometer gear box, axle collar
5. Front axle clamps, with four lockwashers and nuts
6. Front turn signals, each with a bolt, lockwasher, nut, and two flat washers
7. Rear turn signals, each with a cup washer, flat washer, lockwasher, nut, and two rubber dampers
8. Rear view mirrors
9. Taillight assembly, with a rubber damper, three flat rubber dampers, large flat washers, lockwashers, and bolts
10. Rear fender, with two bolts, lockwashers, large flat washers, and a wire clip for the forward mount; four short bolts, lockwashers, and flat washers for the rear mount
11. Miscellaneous:  
Z1000 Owner's manual



## 4 ASSEMBLY

### FRONT FENDER

Turn the lower fork legs so that the fender mounting lugs face inward.

Install the front fender using the four bolts and lockwashers. Mount the brake hose brackets between the fender and the fork legs. Tighten the four bolts securely.

**CAUTION** Do not bend the hydraulic brake pipe during assembly, or it may cause the brake to squeal.

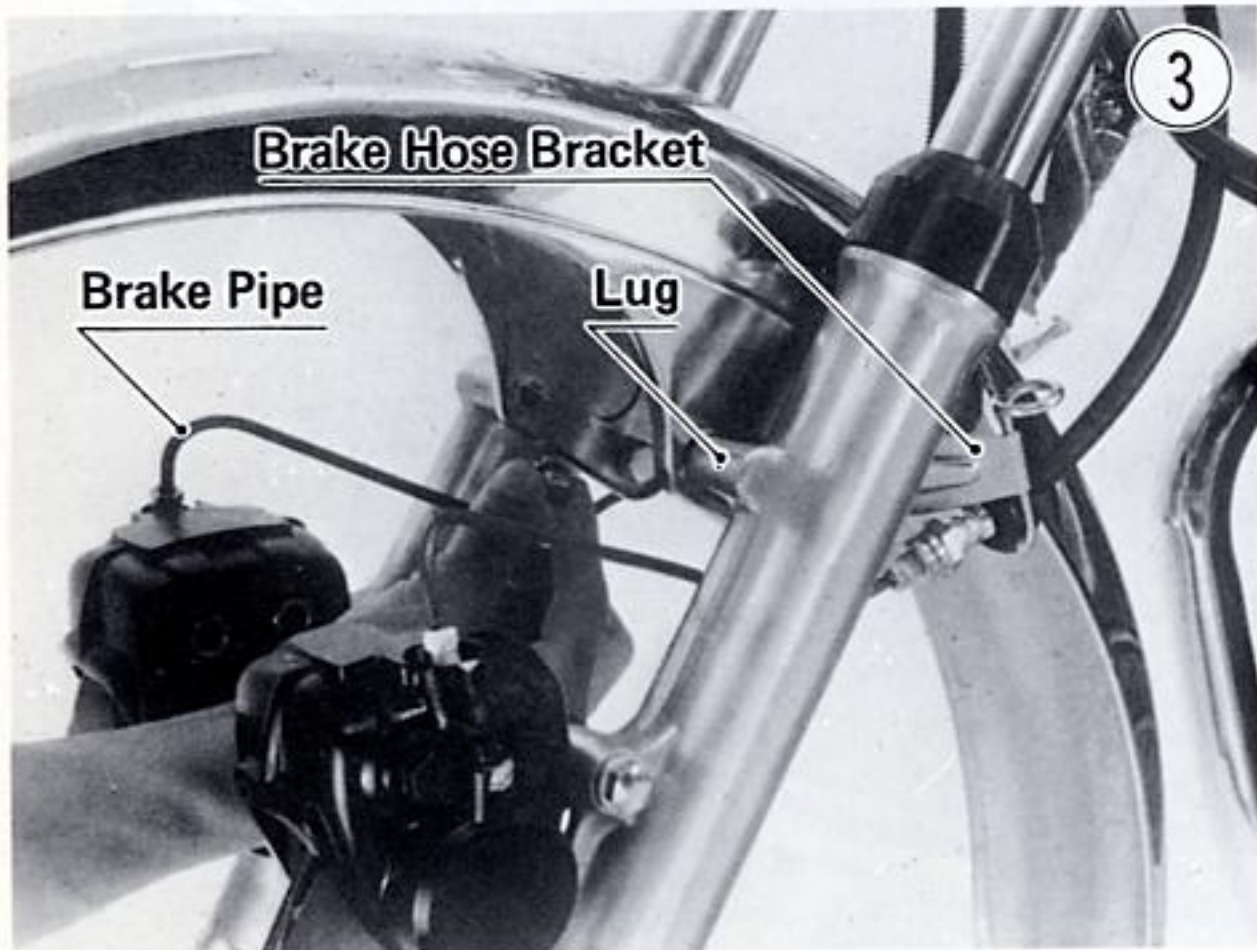

### FRONT WHEEL ASSEMBLY

Check for any loose parts inside the speedometer gear box and the front wheel hub, and fit the gear box to the hub. Be sure to align the tangs in the gear box with the slots in the wheel hub.

**WARNING** Loose parts in the speedometer gear box and hub, or misalignment may cause the front wheel to lock, resulting in loss of control.

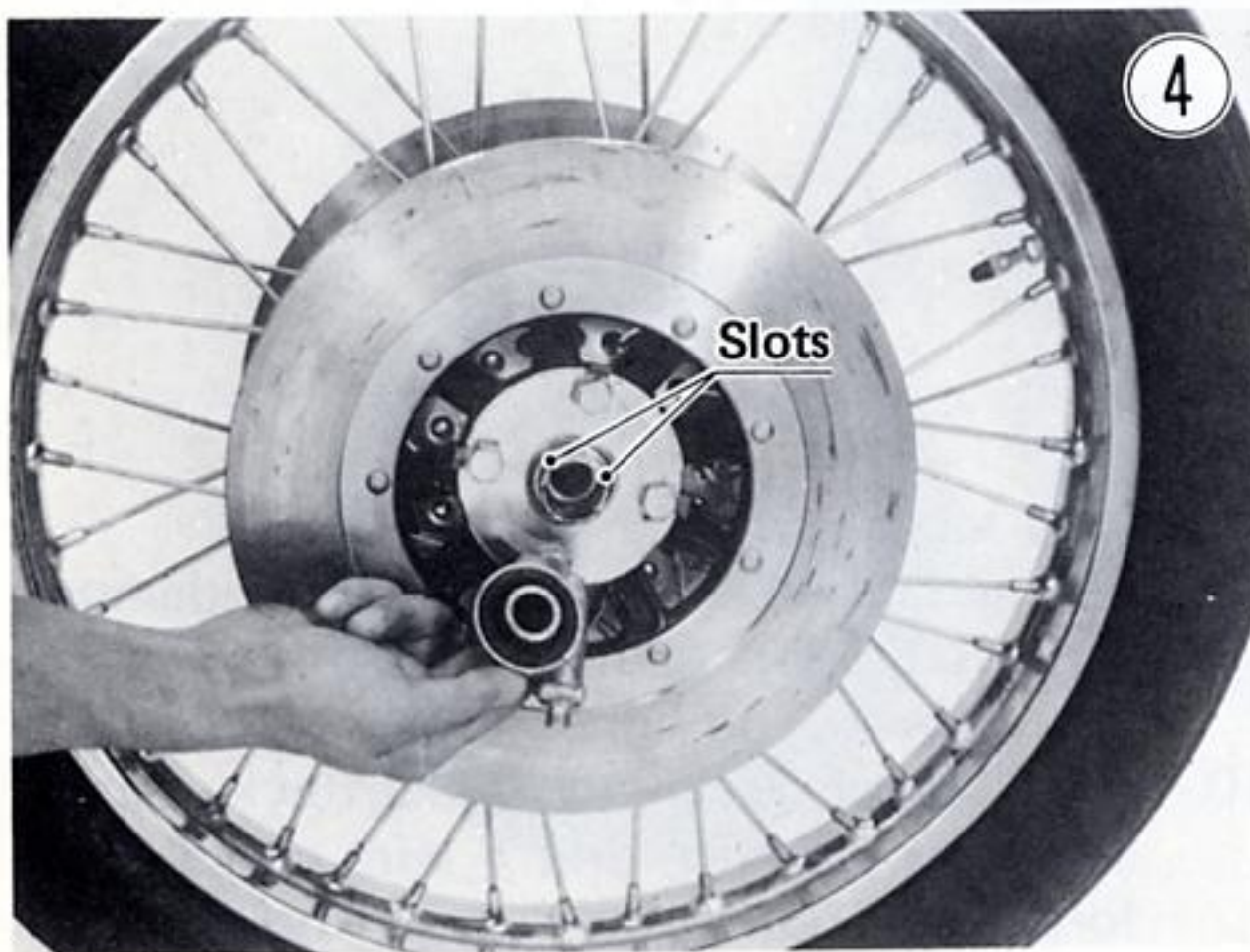

Smear thick grease on the axle collar and insert it into the hub grease seal. Insert the axle through the hub, put on the axle sleeve nut, and screw on both nuts evenly.

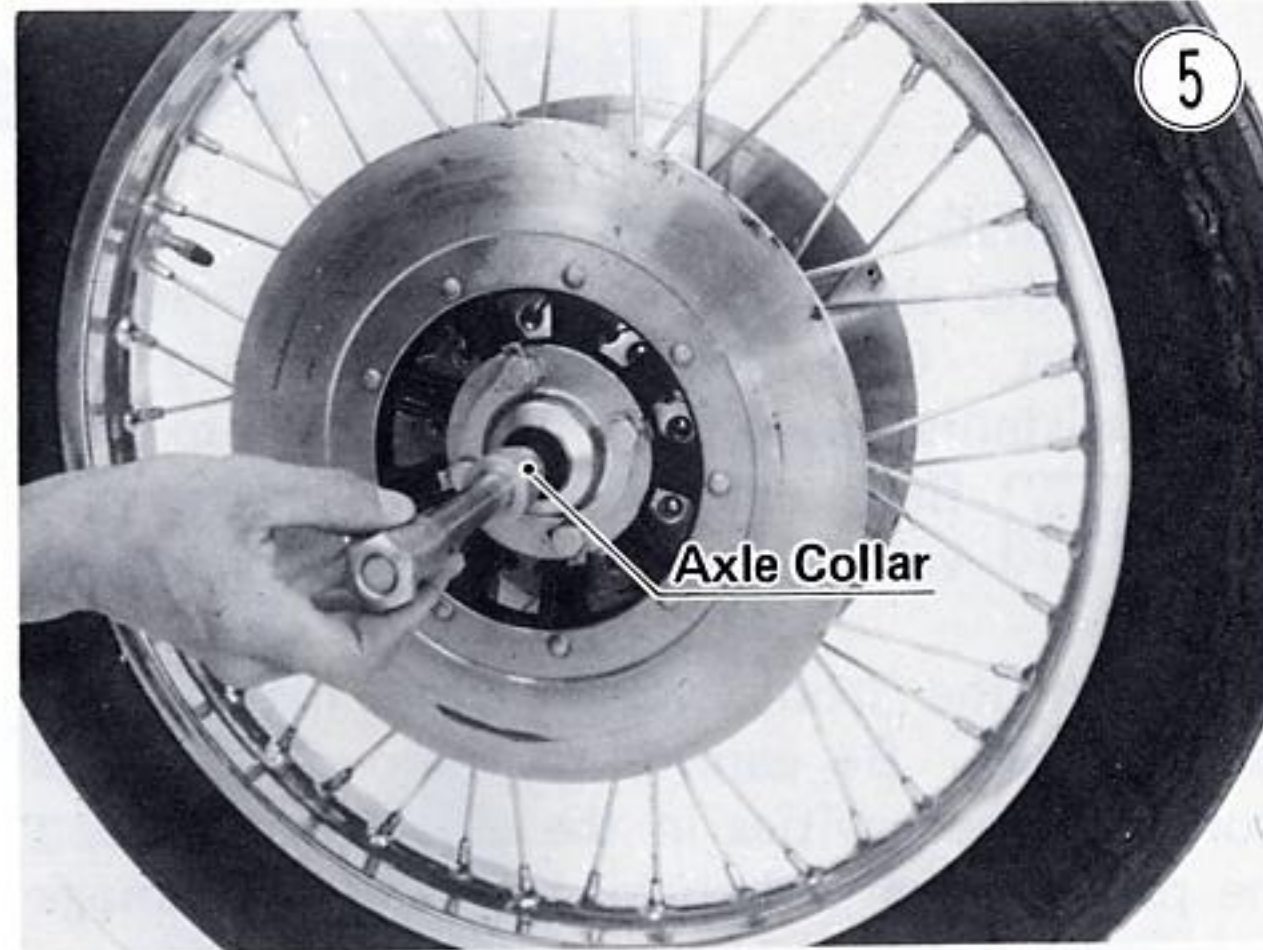

Tighten the axle nuts with 8.0 kg-m (58 ft-lbs) of torque, and then turn the speedometer gear box to check for binding.

**WARNING** If the axle is not securely tightened, an unsafe riding condition may result.

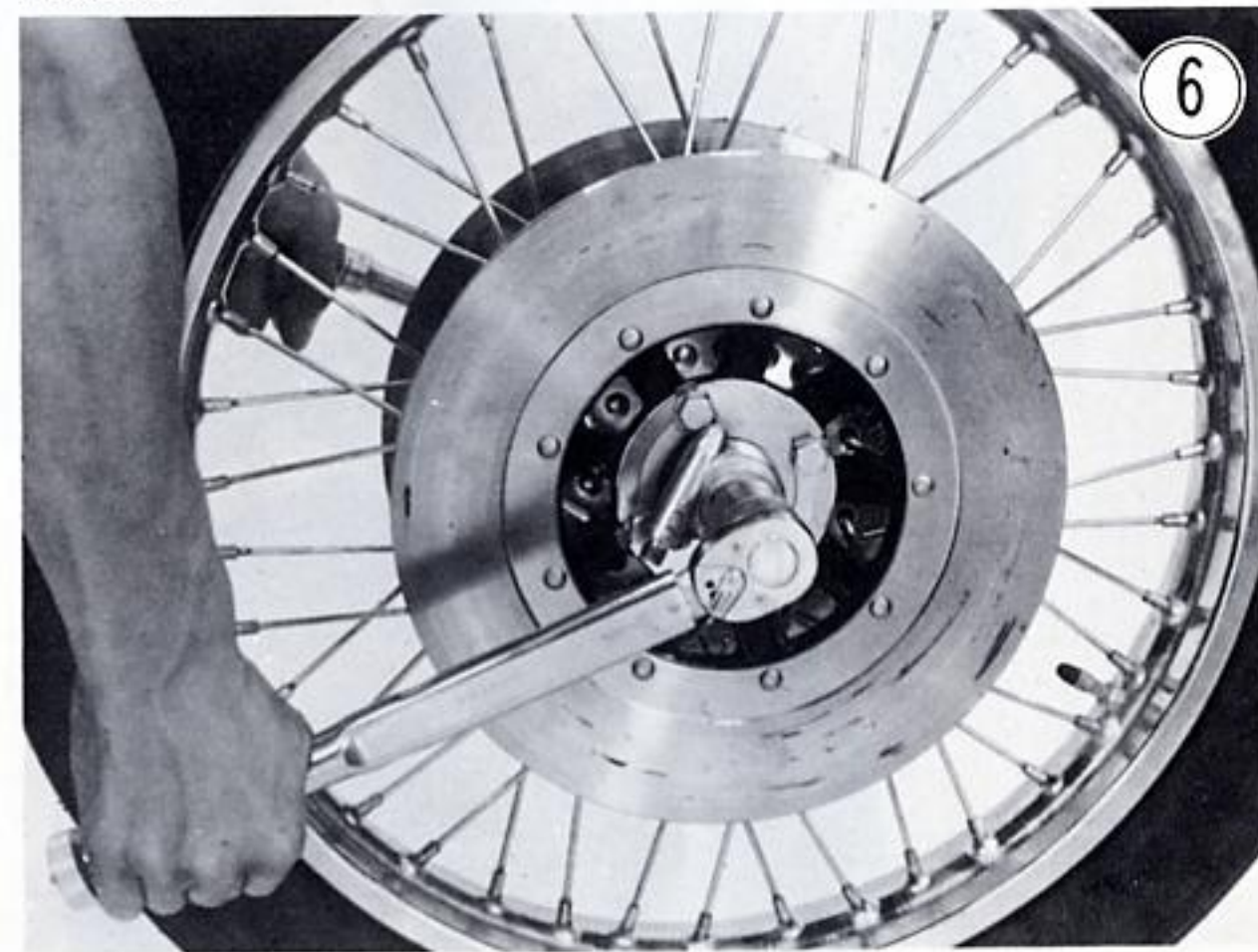

### FRONT WHEEL INSTALLATION

To install the front wheel, one of the disc brake calipers must be removed from the front fork. Being careful not to bend the hydraulic brake pipe, remove the two mounting bolts for the caliper, and put the caliper aside.

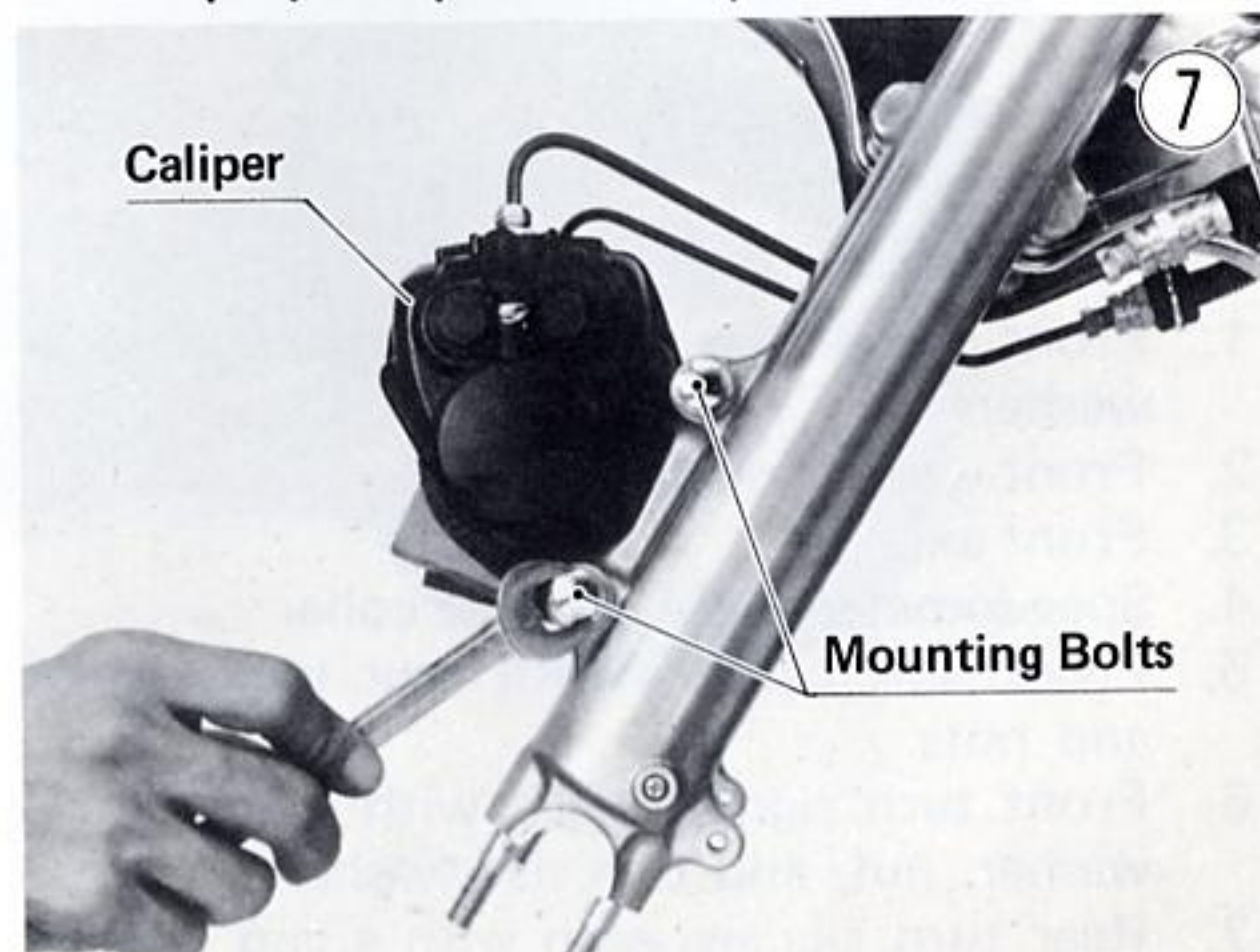

Pull the plastic guards off the axle clamp studs and check the studs for damaged threads.



Remove the cardboard spacer from between the disc brake pads. Roll the front wheel into position with the disc between the caliper pads.



Loosely mount the axle clamps with a nut and lockwasher on each stud, making sure the arrow on the clamp points toward the front.

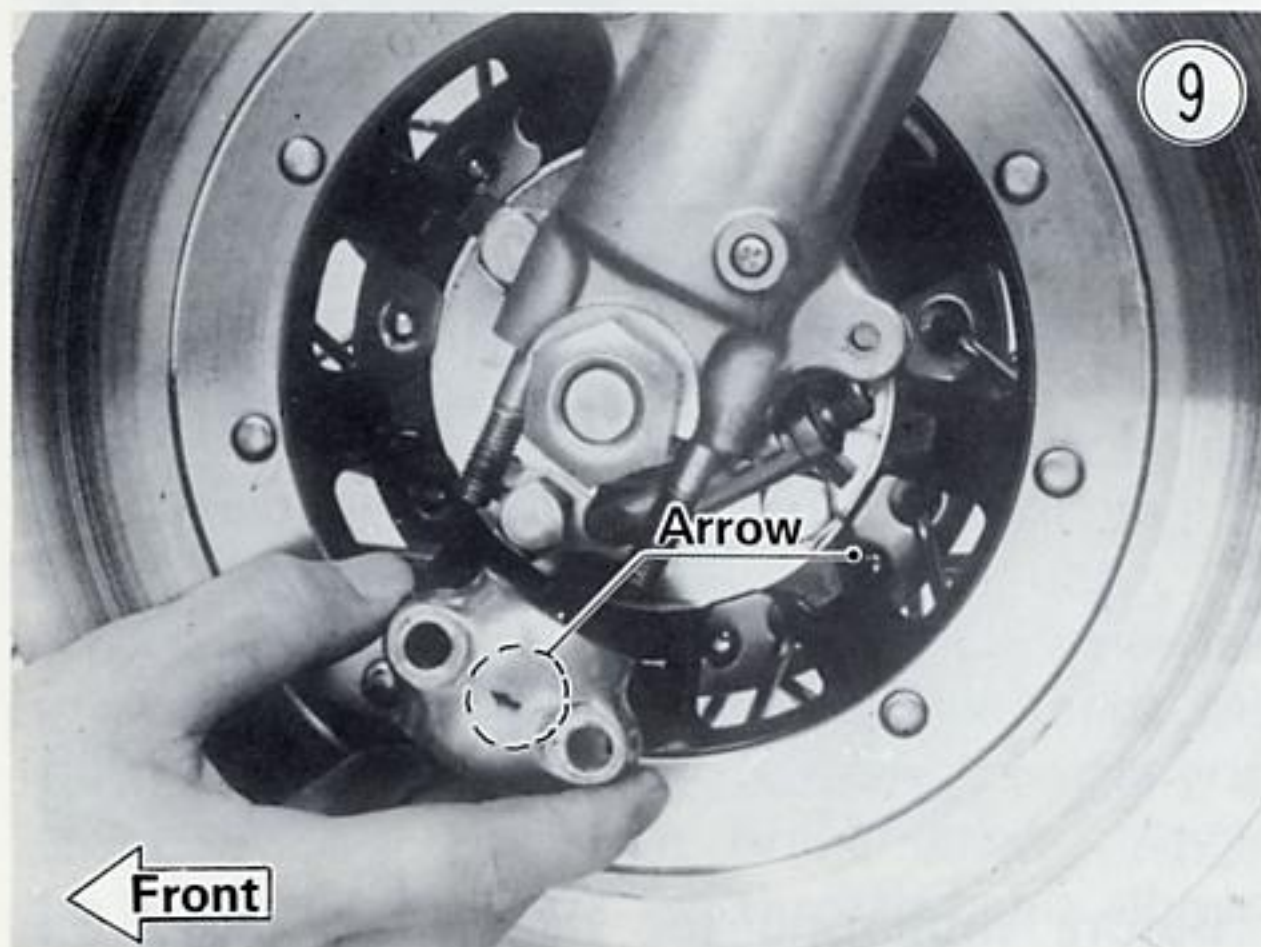

Turn the speedometer gear box so that it points to the two o'clock position. Be sure that the small projection on the gear box does not catch on the lower part of the left fork leg.

**CAUTION** Failure to correctly align the speedometer gear box may result in early breakage of the speedometer cable.

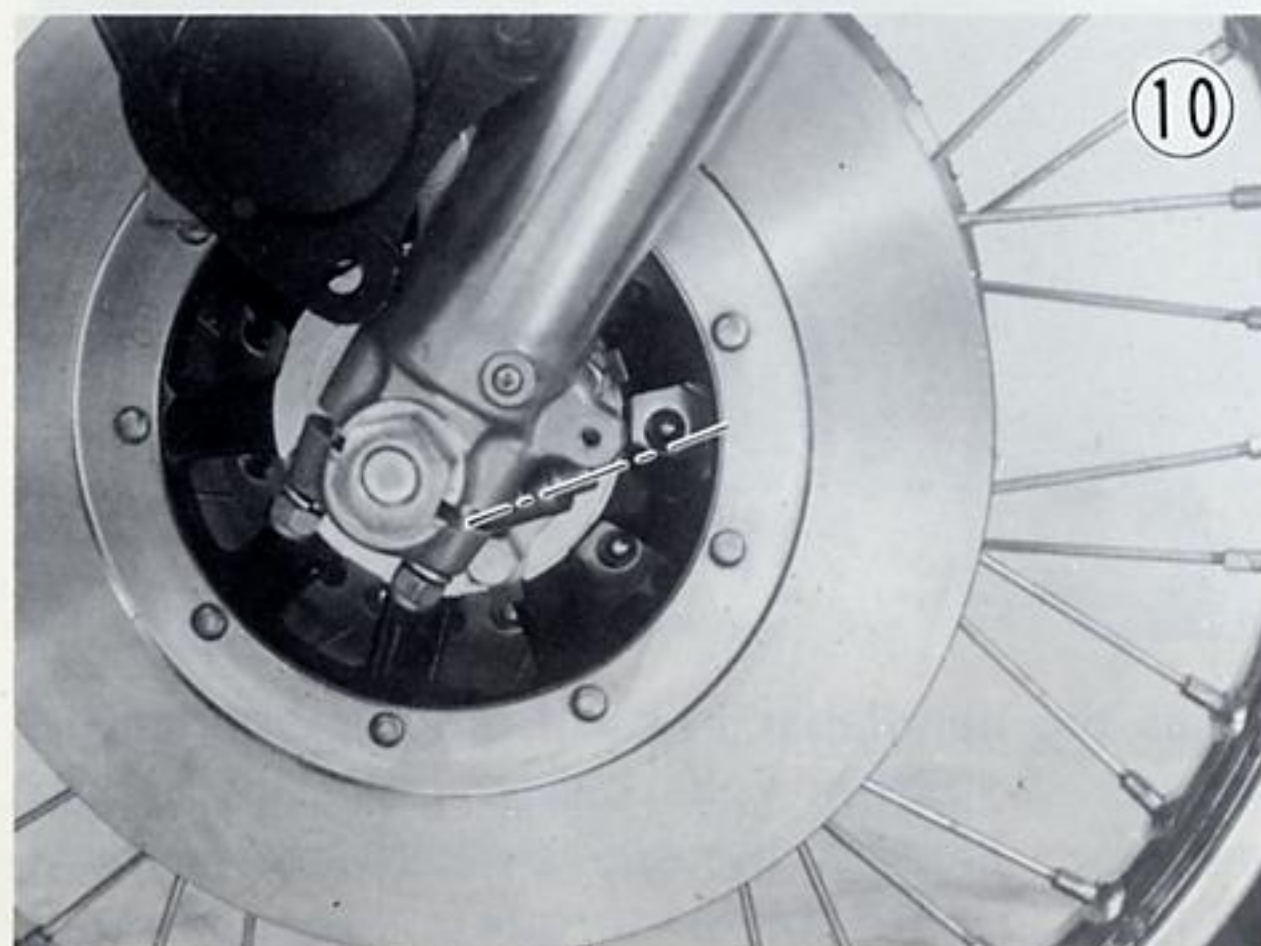

Tighten the left-hand clamp nuts, front first and then the rear, with 1.9 kg-m (13.5 ft-lbs) of torque. Compress the front fork several times to center the axle, and then tighten the right-hand clamp in the same manner. If the axle clamp is correctly installed, there will be no gap at the front and an even gap at the rear after tightening.

**WARNING** If the axle clamps are not correctly installed or tightened, an unsafe riding condition may result.

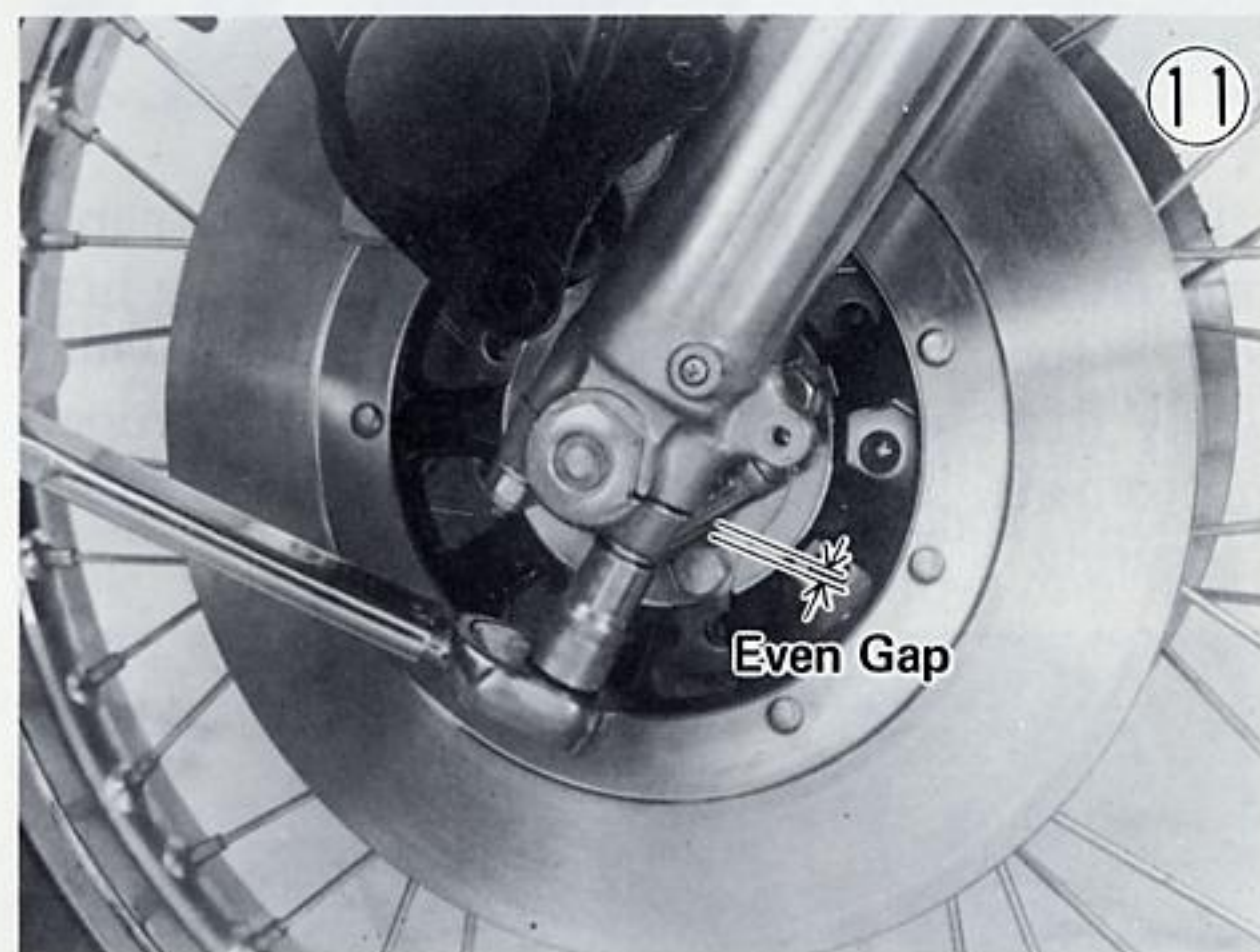

Mount the brake caliper which was removed, and insert the mounting bolts, lockwashers, and flat washers. Tighten the bolts to 4.0 kg-m (29 ft-lbs) of torque.

**WARNING** If the bolts are not securely tightened, brake may not work properly, resulting in an unsafe riding condition.

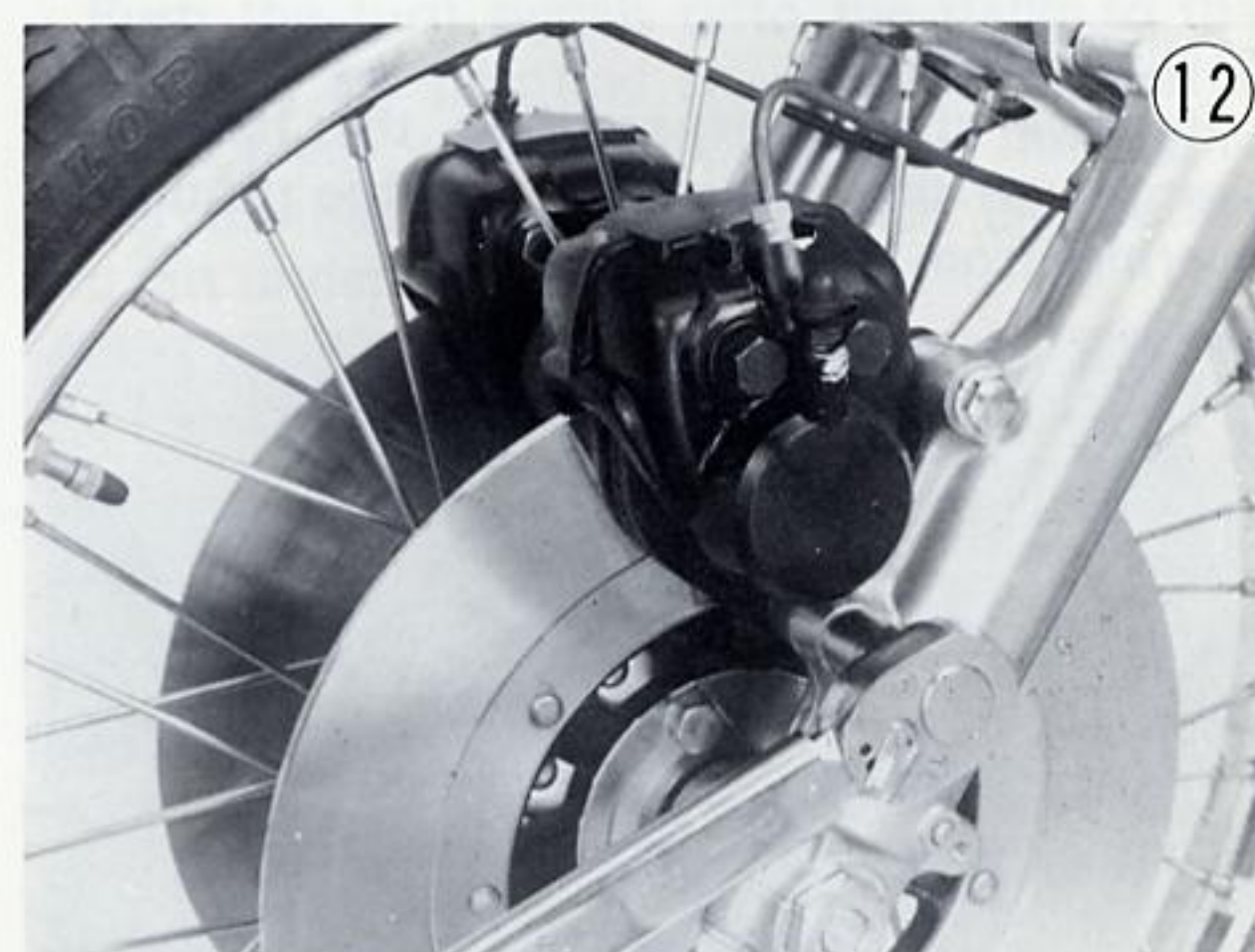

Push the protective rubber grommet on the brake hose into the brake hose bracket.



## 6 ASSEMBLY

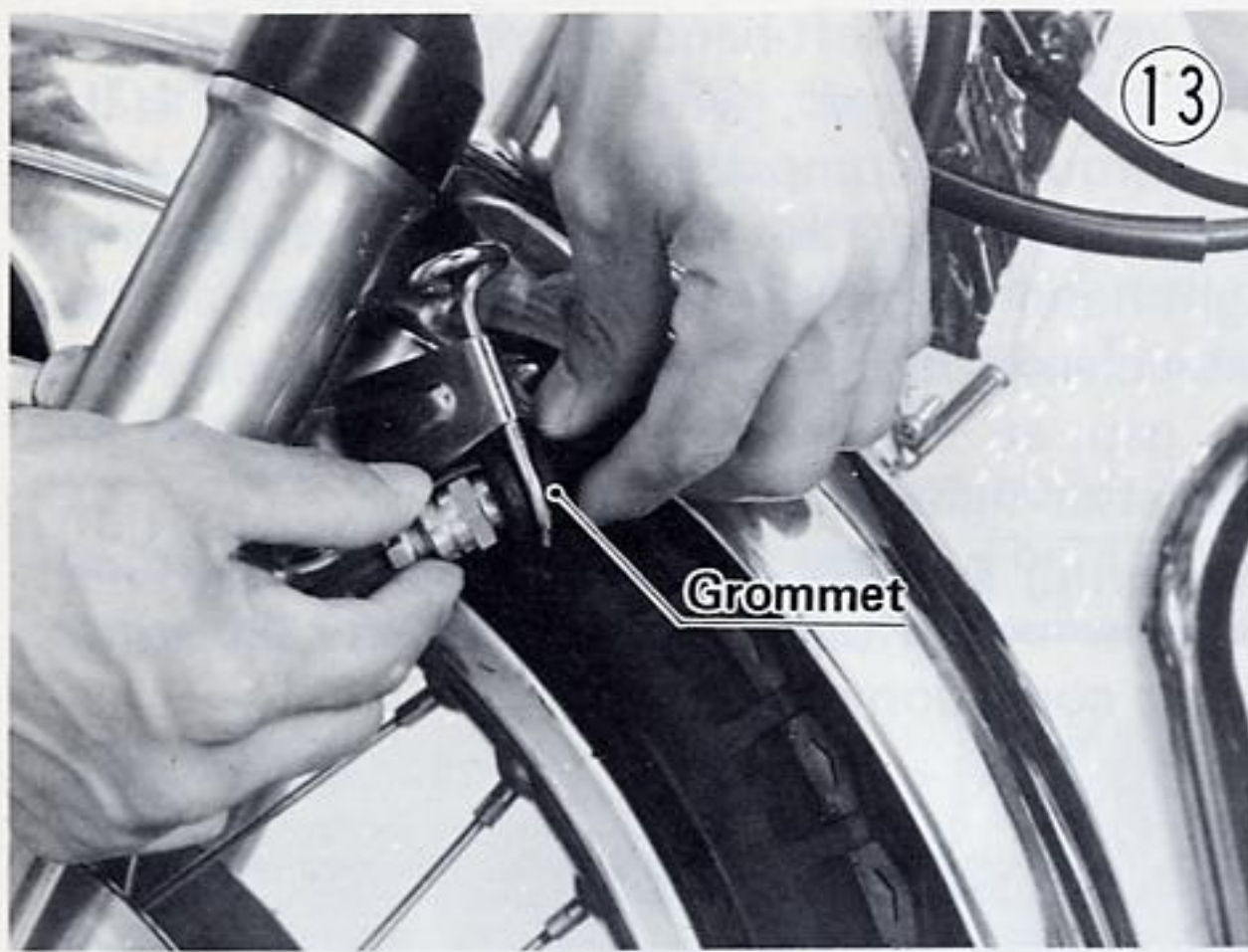

Route the lower end of the speedometer cable through the cable guide on the brake hose bracket. Insert the cable into its socket, while slowly rotating the front wheel to insure proper engagement. Screw on the cable nut and tighten it securely.

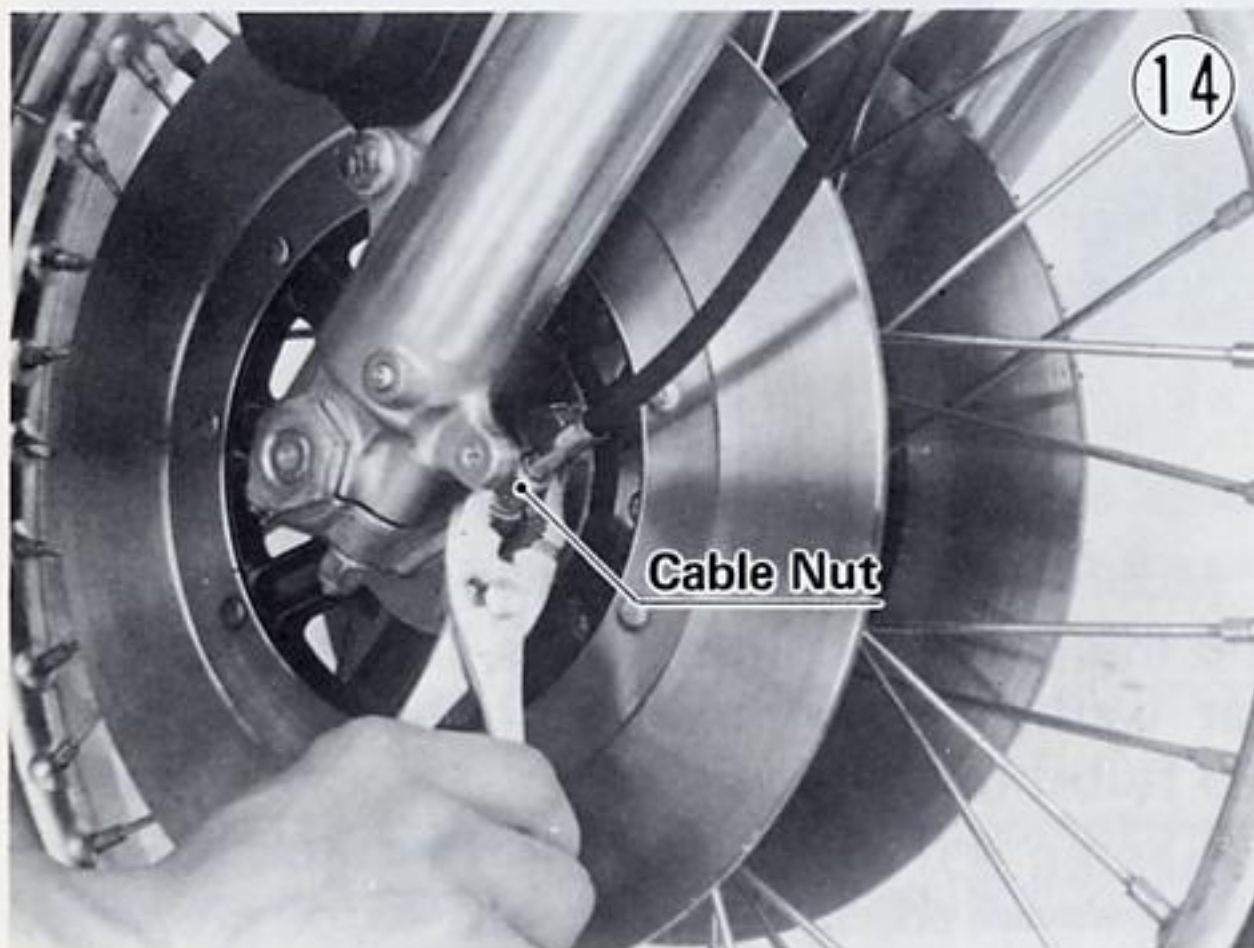

### HANDLEBAR

Remove the wires securing the handlebar assembly to the frame. Remove the protective coverings from the handlebar.



Remove the front master cylinder and let it hang free.

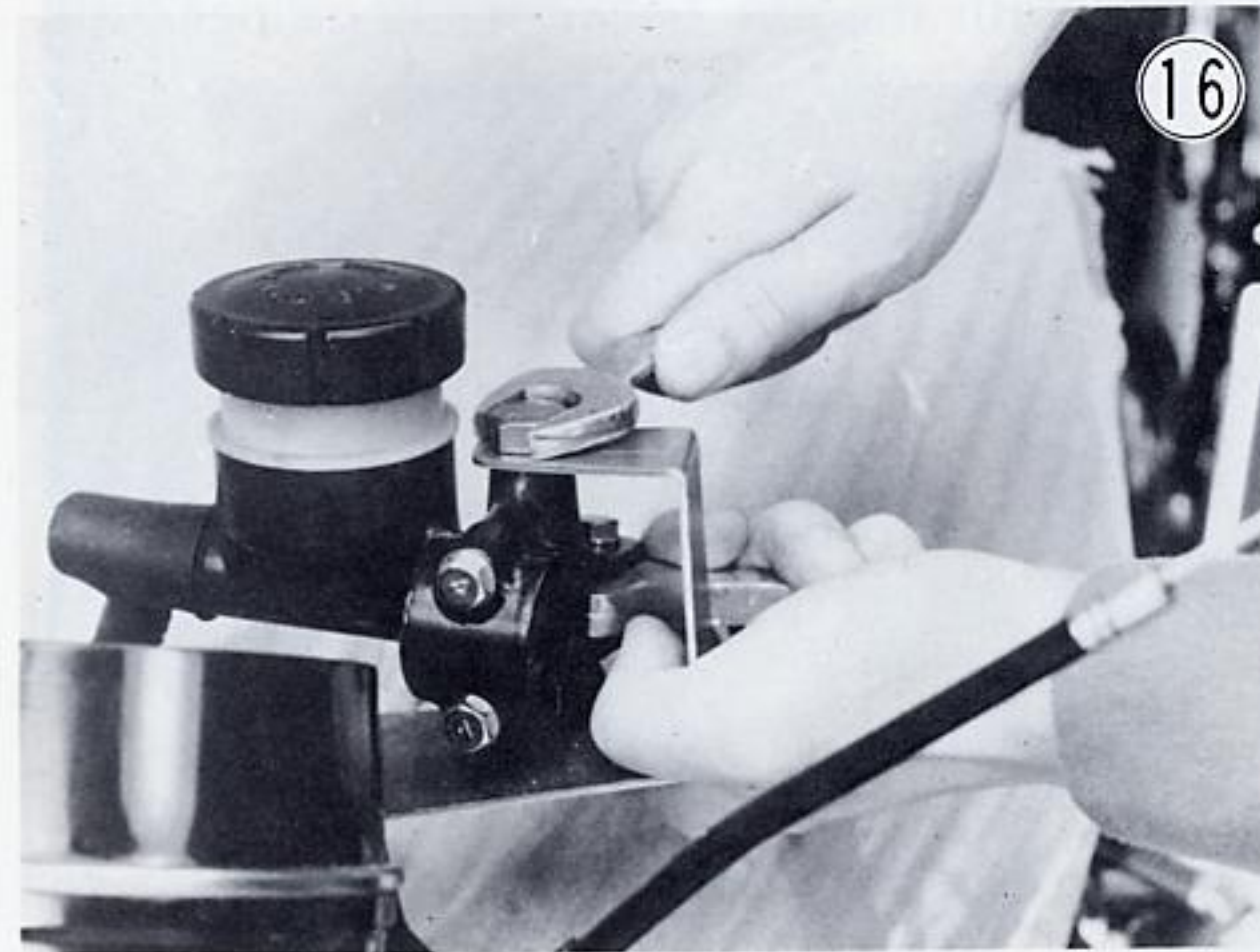

Remove the clamp bolts, lockwashers, clamps, and metal plate. Discard the metal plate.

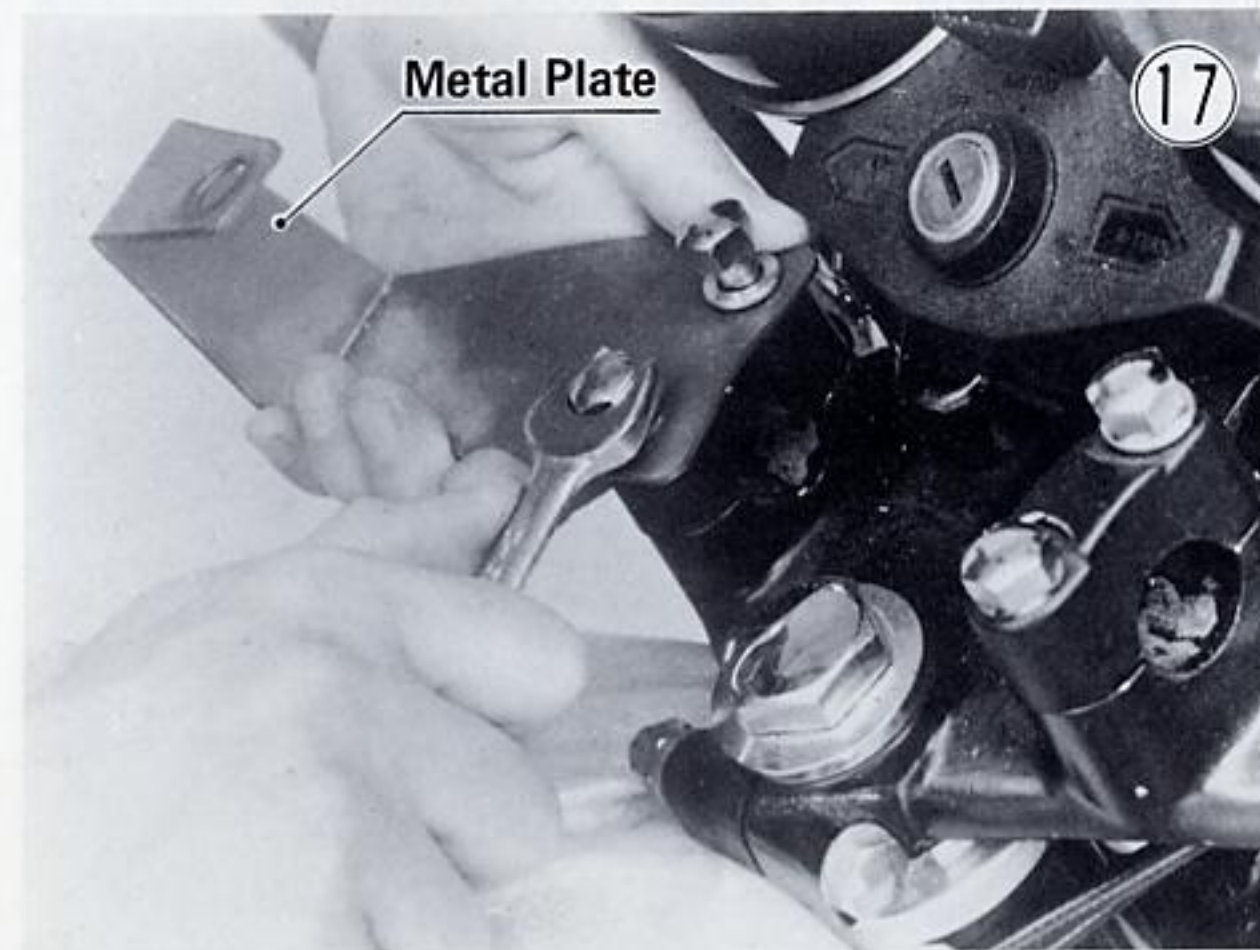

Before mounting the handlebar, route the wires protruding from the center of the handlebar between the indicator panel and the stem head.

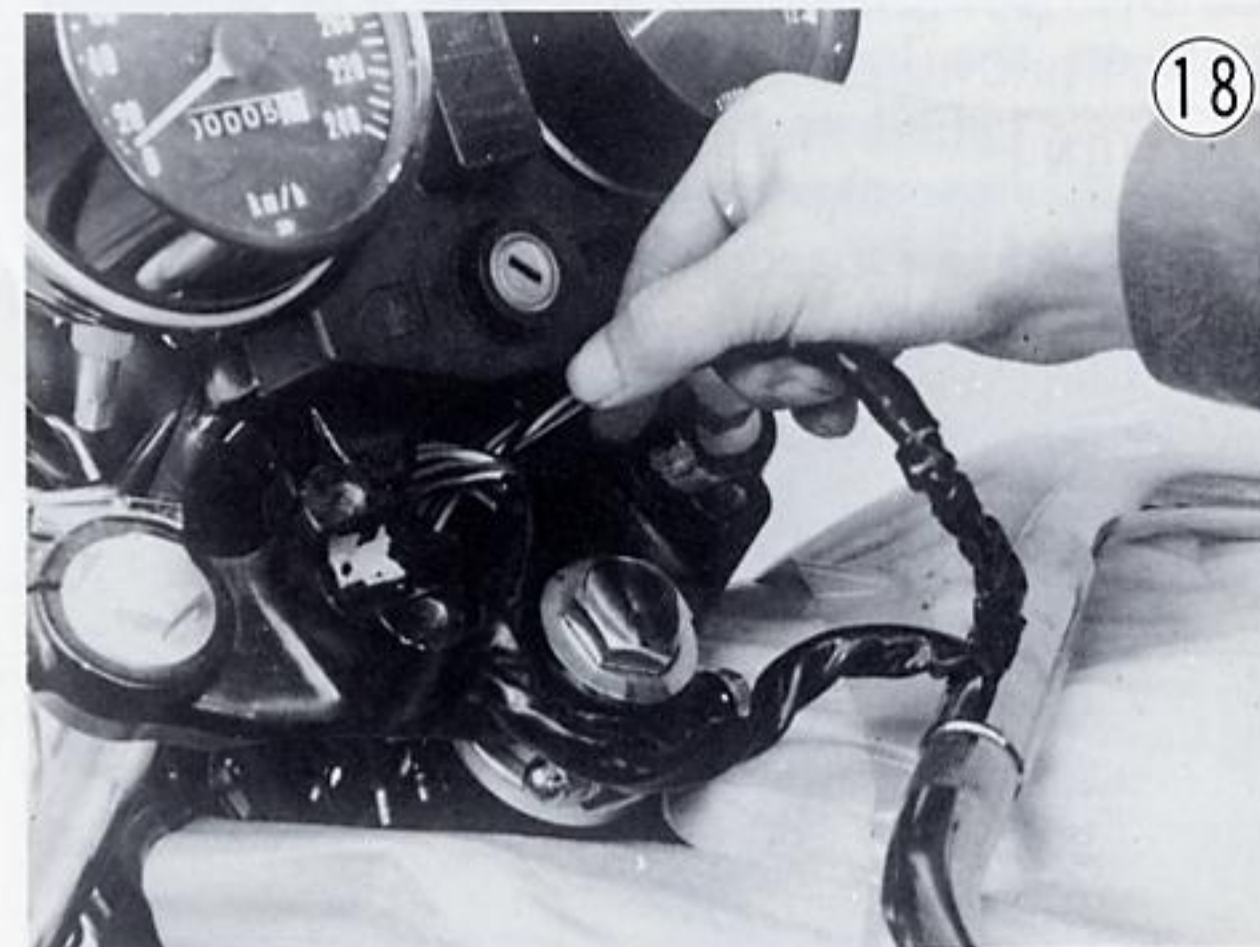

Set the handlebar in position, fit the clamps, and screw in the four clamp bolts and lockwashers. Tighten the clamp bolts evenly with 1.9 kg-m (13.5 ft-lbs) of torque.



**NOTE:** The handlebar should be installed so that the angle of the handlebar matches the front fork angle to obtain a comfortable riding position.

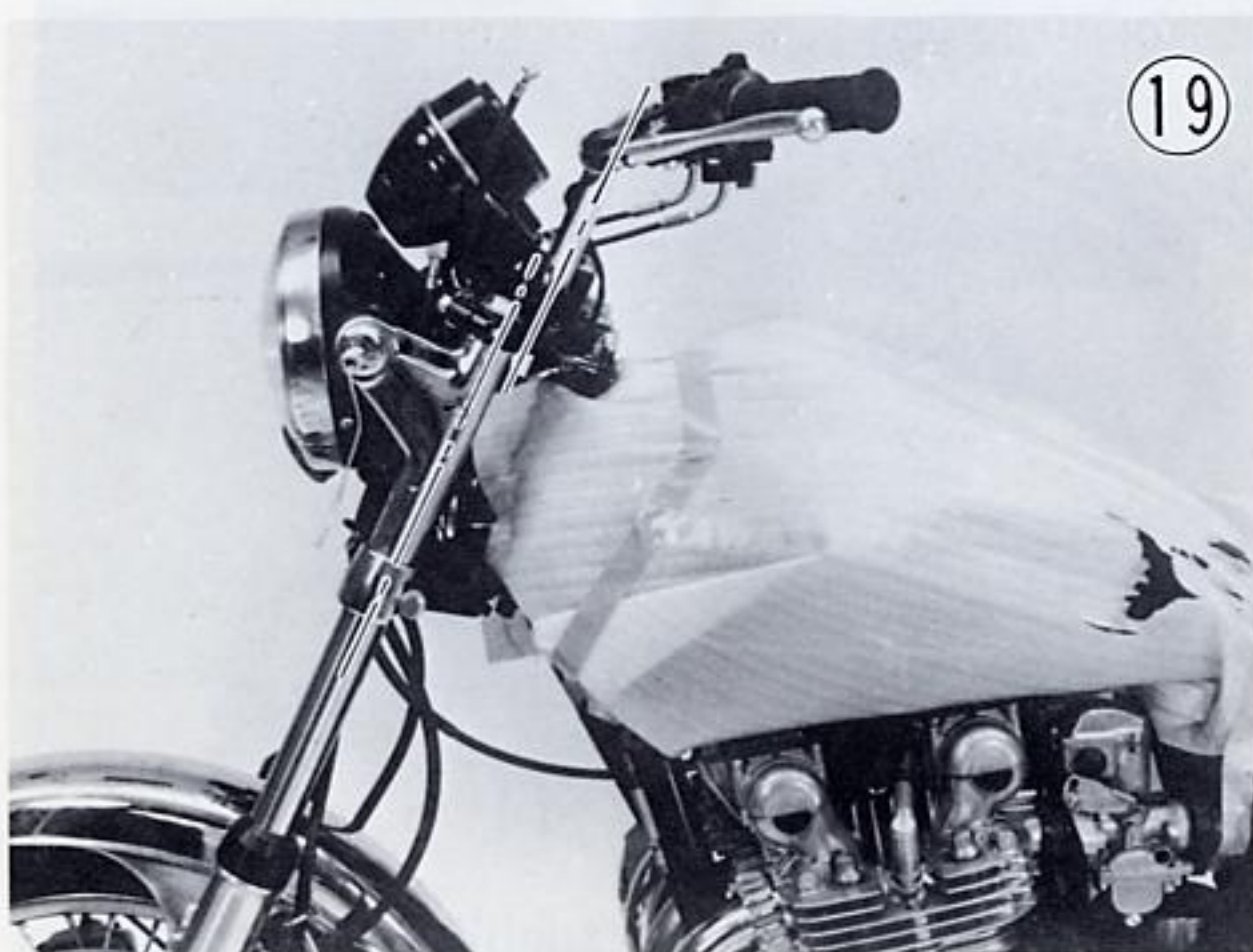

### MASTER CYLINDER

Mount the front brake master cylinder next to the throttle grip assembly. The small projection on the side of the clamp should point toward the grip. Tighten first the upper clamp bolt and then the lower, with 0.8 kg-m (69 in-lbs) of torque.

**NOTE:** If the clamp is correctly installed, there will be no gap at the top of the clamp and an even gap at the bottom after tightening.

**WARNING** Leave sufficient space between the master cylinder holder and the throttle grip assembly so that the throttle grip assembly does not limit brake lever. Angle the brake lever so that the throttle cable elbows do not limit brake lever application.

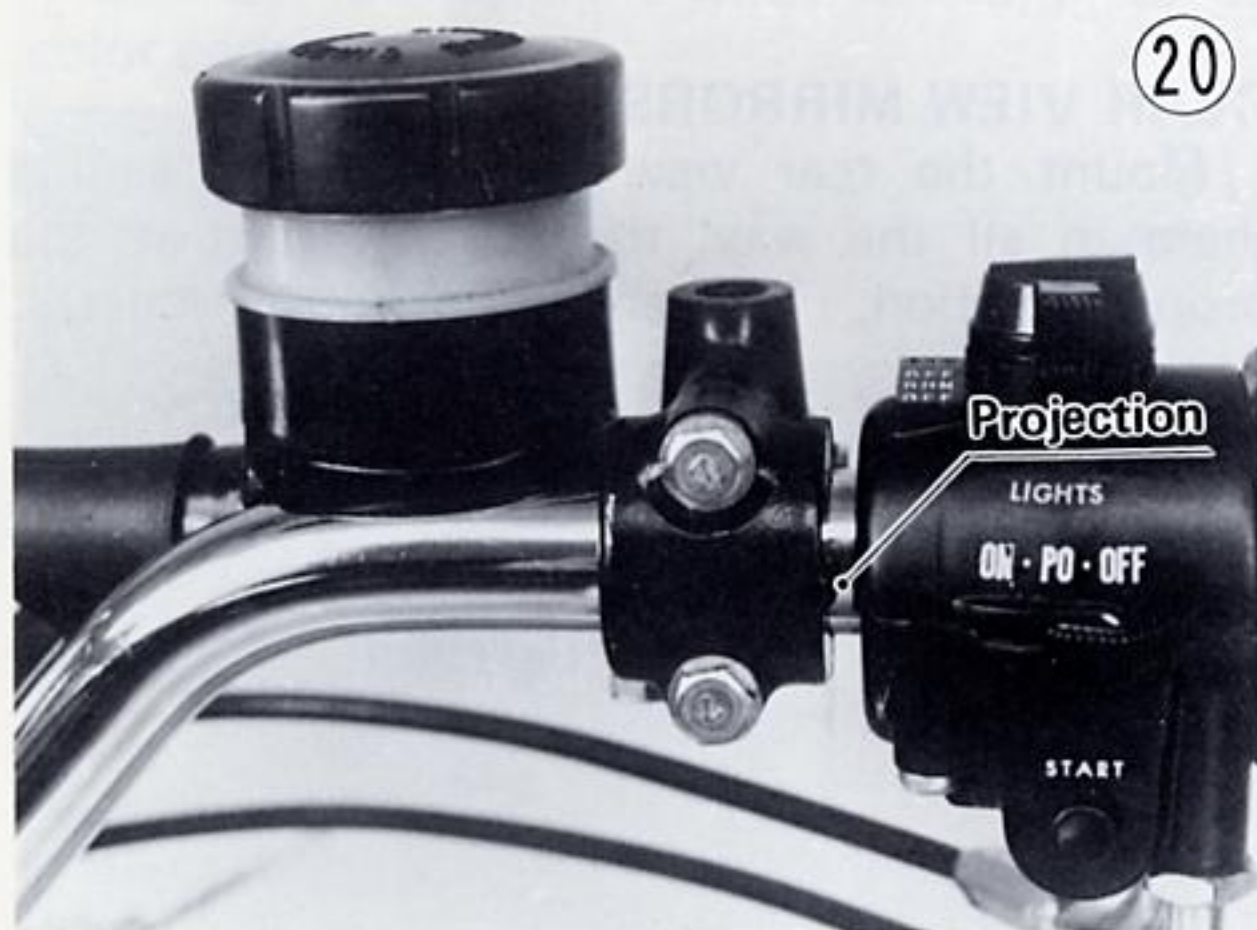

### CLUTCH LEVER

Position the clutch lever so that it can be operated easily while riding. Tighten the clamp bolt securely.

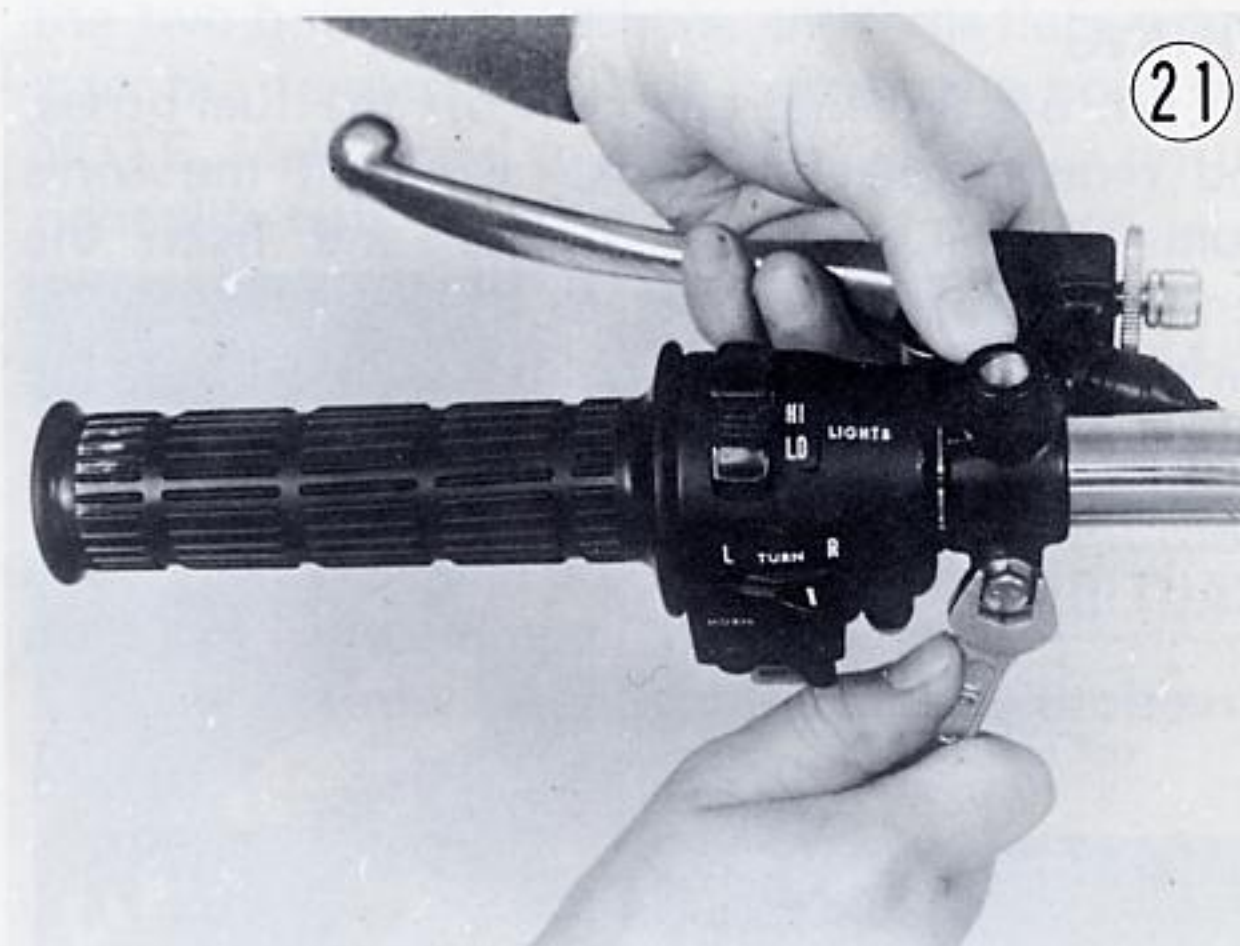

### FRONT TURN SIGNALS

Connect the turn signal leads to the wires protruding from the ends of the front turn signal stalks. If the wire has pulled back into the stalk, it will be necessary to remove the headlight unit and push the wire out.

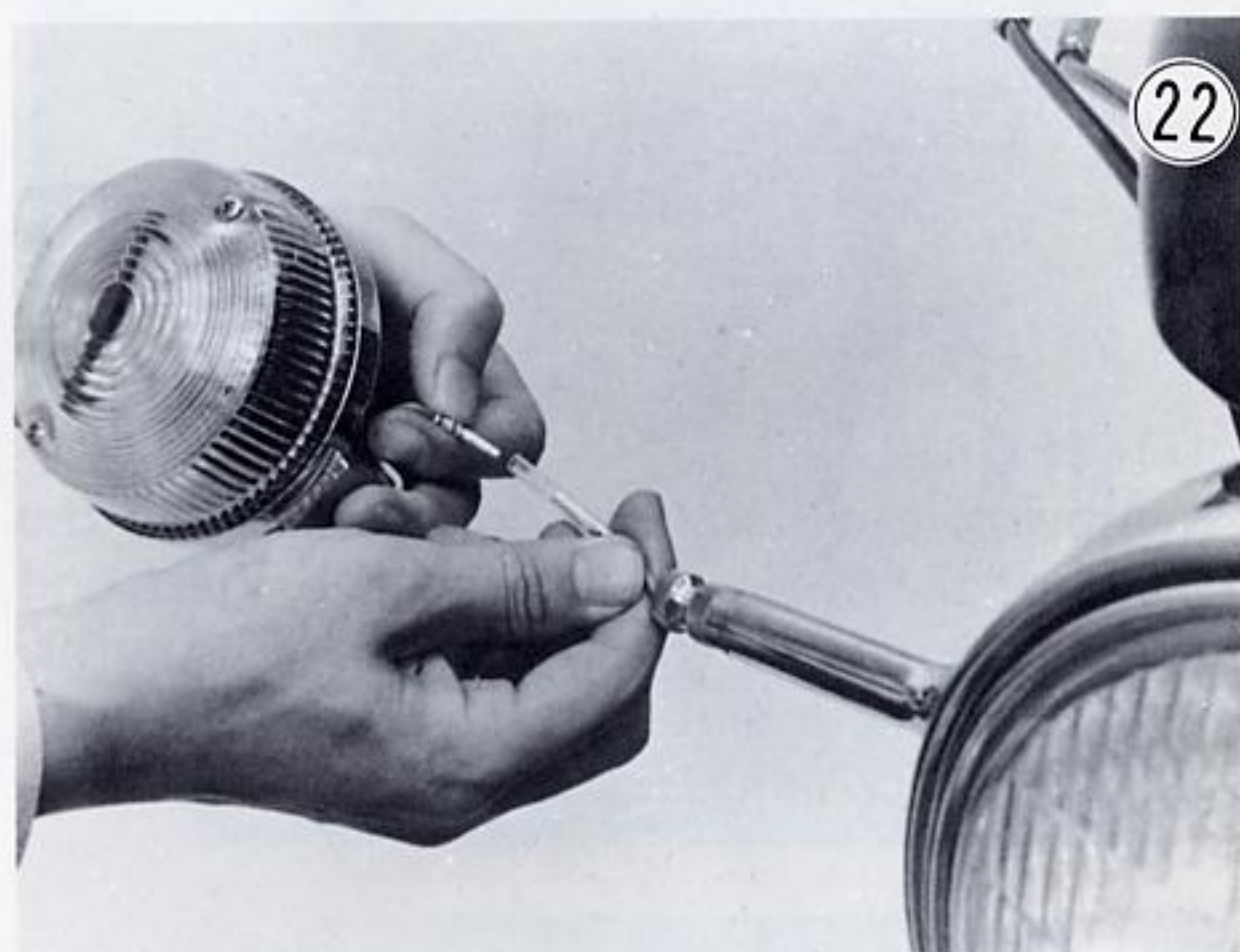

Push the turn signals onto the stalks so that the signals are pointing straight ahead. Fasten each in place with a bolt with one flat washer under the head, and a flat washer, lockwasher, and nut under the unit.

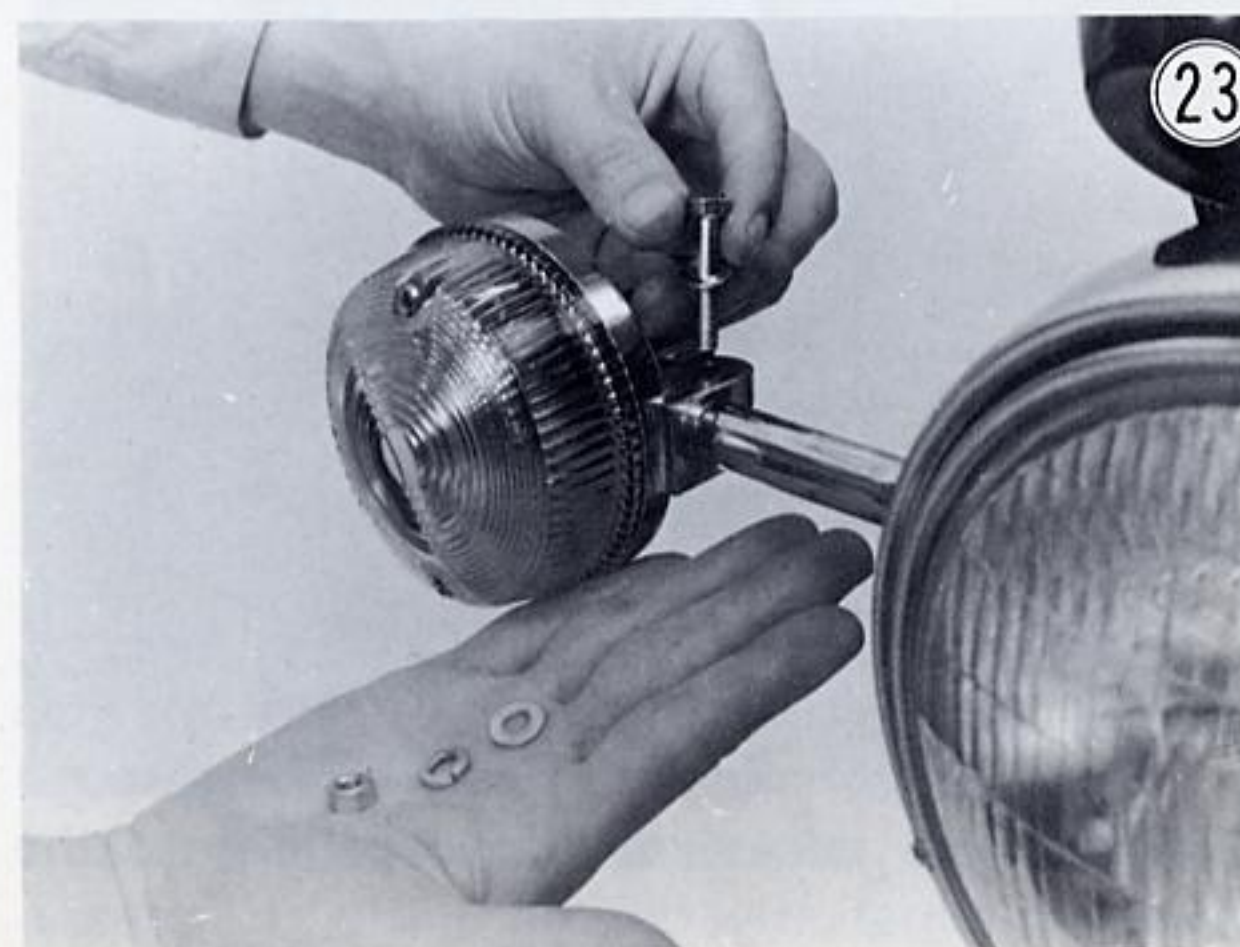



## 8 ASSEMBLY

### WIRING

Turn off the fuel tap, pull off the fuel hoses, and remove the fuel tank. Connect the wires from the clutch lever holder and from the center of the handlebar to the main electrical wires according to the color codes. Slide the rubber boot onto the wire connectors and re-install the fuel tank.

**CAUTION** Make sure the steering stem can be turned completely in both directions without pinching the wires.

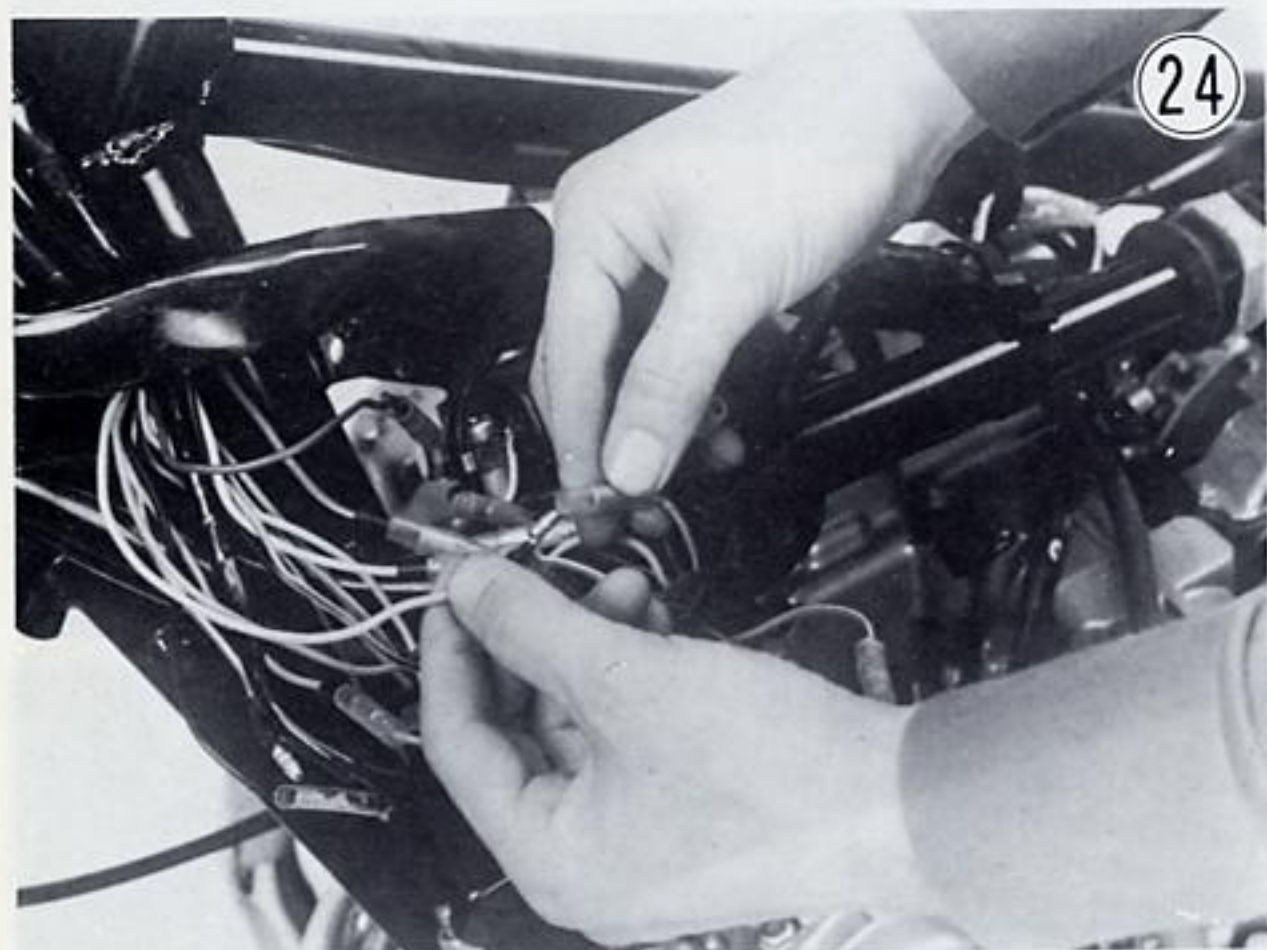

### CLUTCH CABLE

Remove the clutch adjusting cover from the left side of the engine. Loosen the locknut, and back out the adjusting screw a couple of turns. This will give the clutch cable plenty of play. Install the clutch adjusting cover.

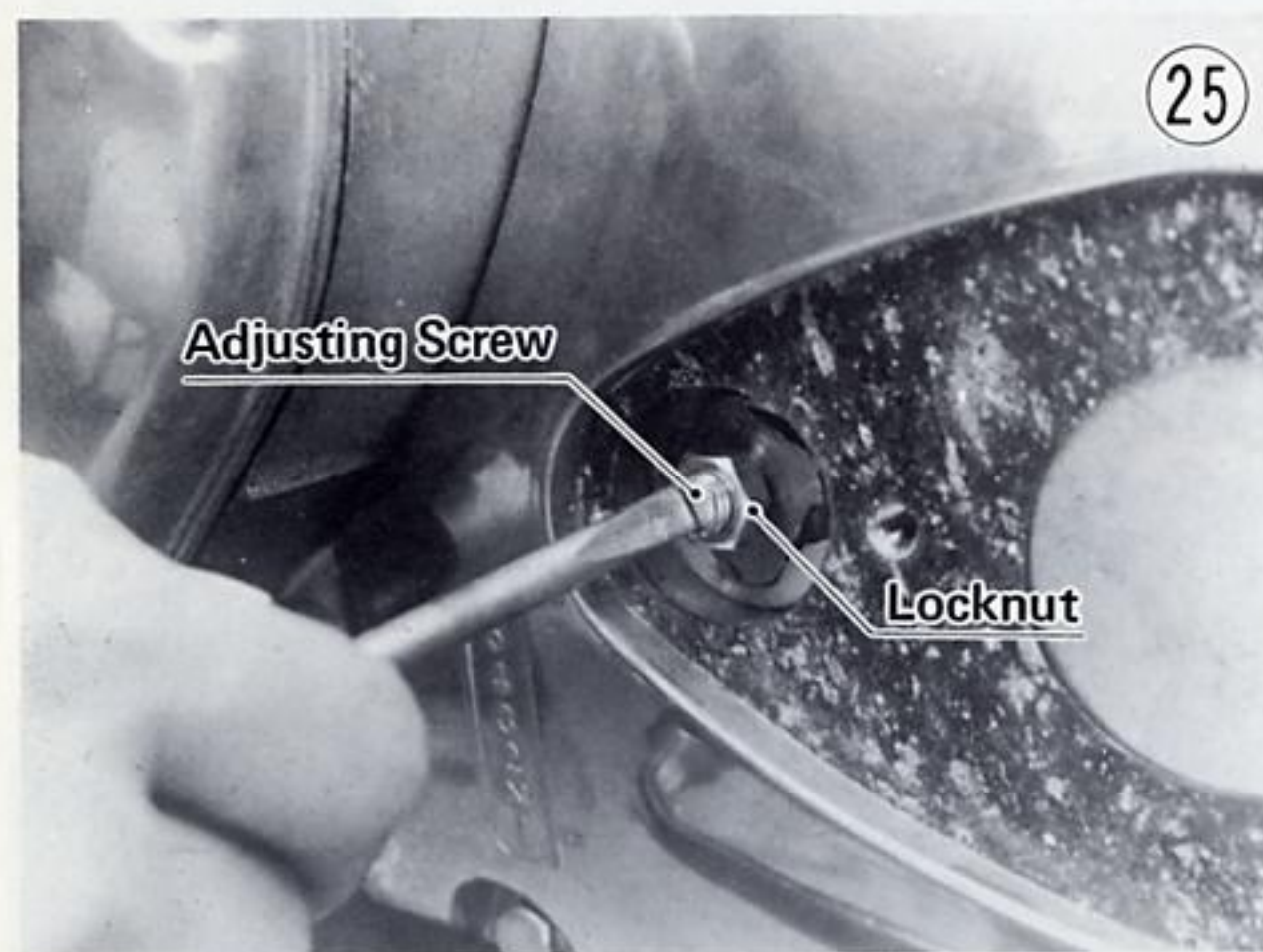

Line up the slots on the clutch lever, locknut, and adjuster. Fit the end of the inner cable into the lever socket, slide the inner cable through the slots, and release the outer cable into the adjuster.

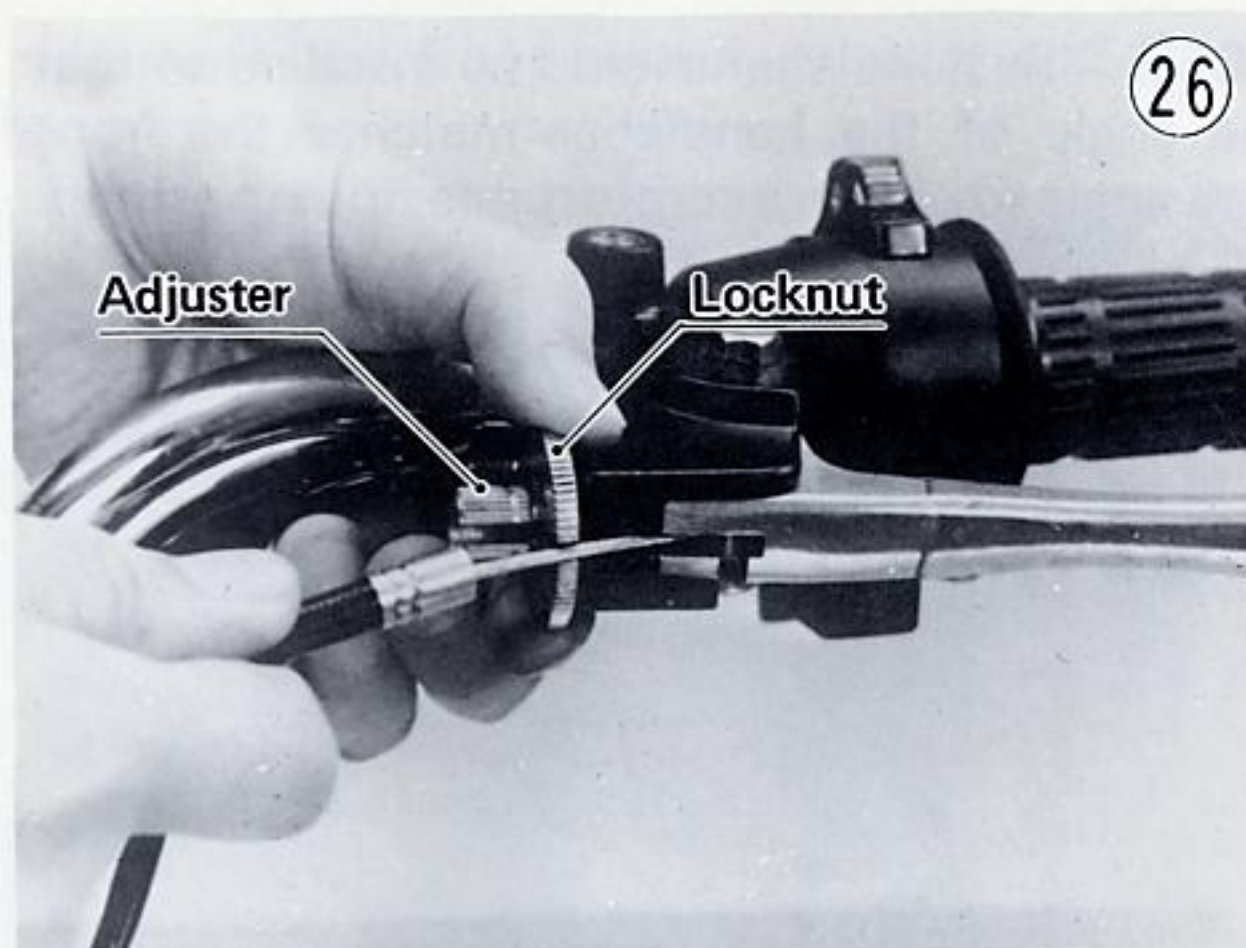

### WIRING STRAPS

Fit the wiring straps to the wiring harness on the handlebar, making sure that the wiring is not stretched or kinked.

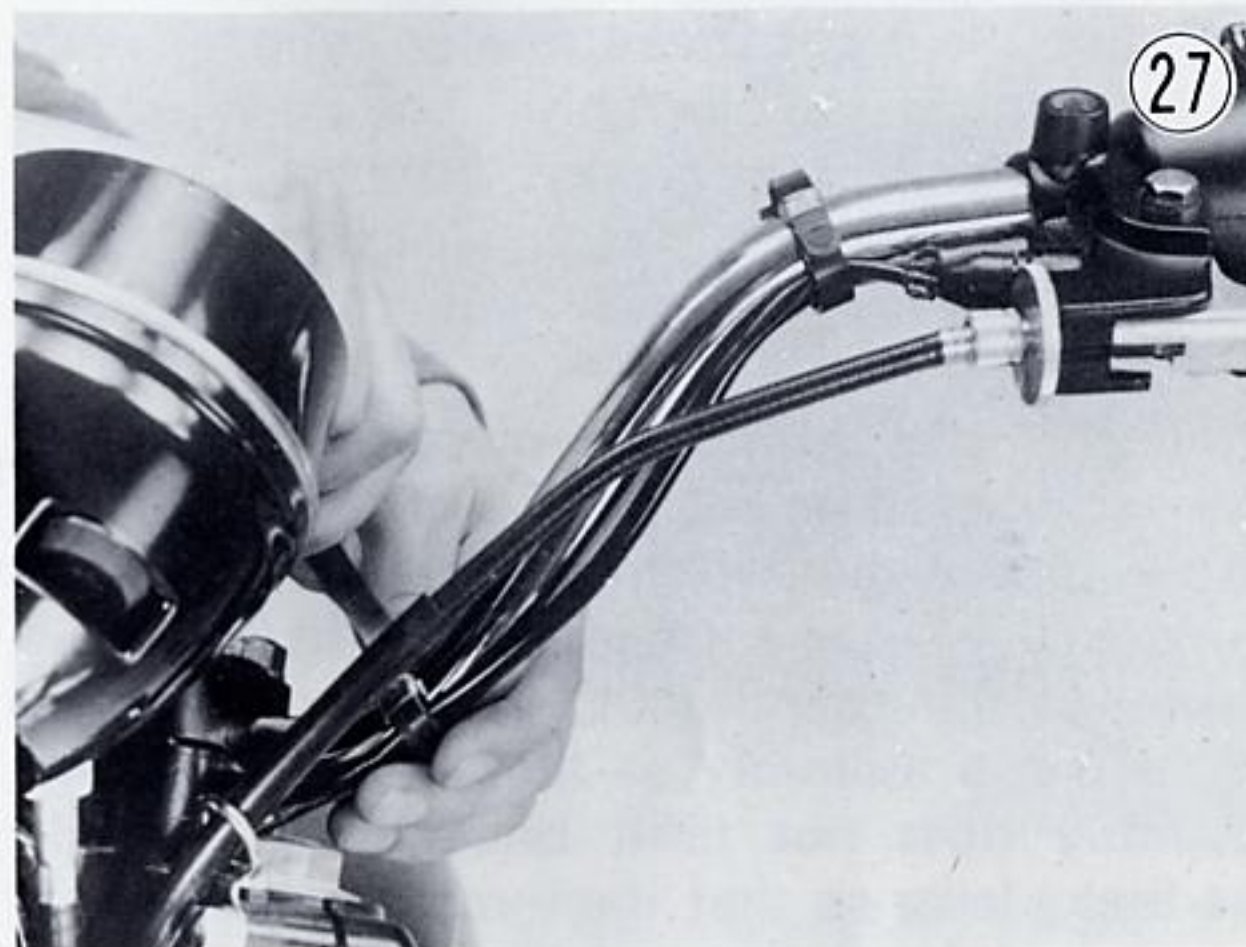

### REAR VIEW MIRRORS

Mount the rear view mirrors by threading them in all the way, then backing out to the proper position. Tighten the locknuts securely.





**TAILLIGHT ASSEMBLY**

Insert the taillight wires into the holes in the rubber damper and taillight bracket.

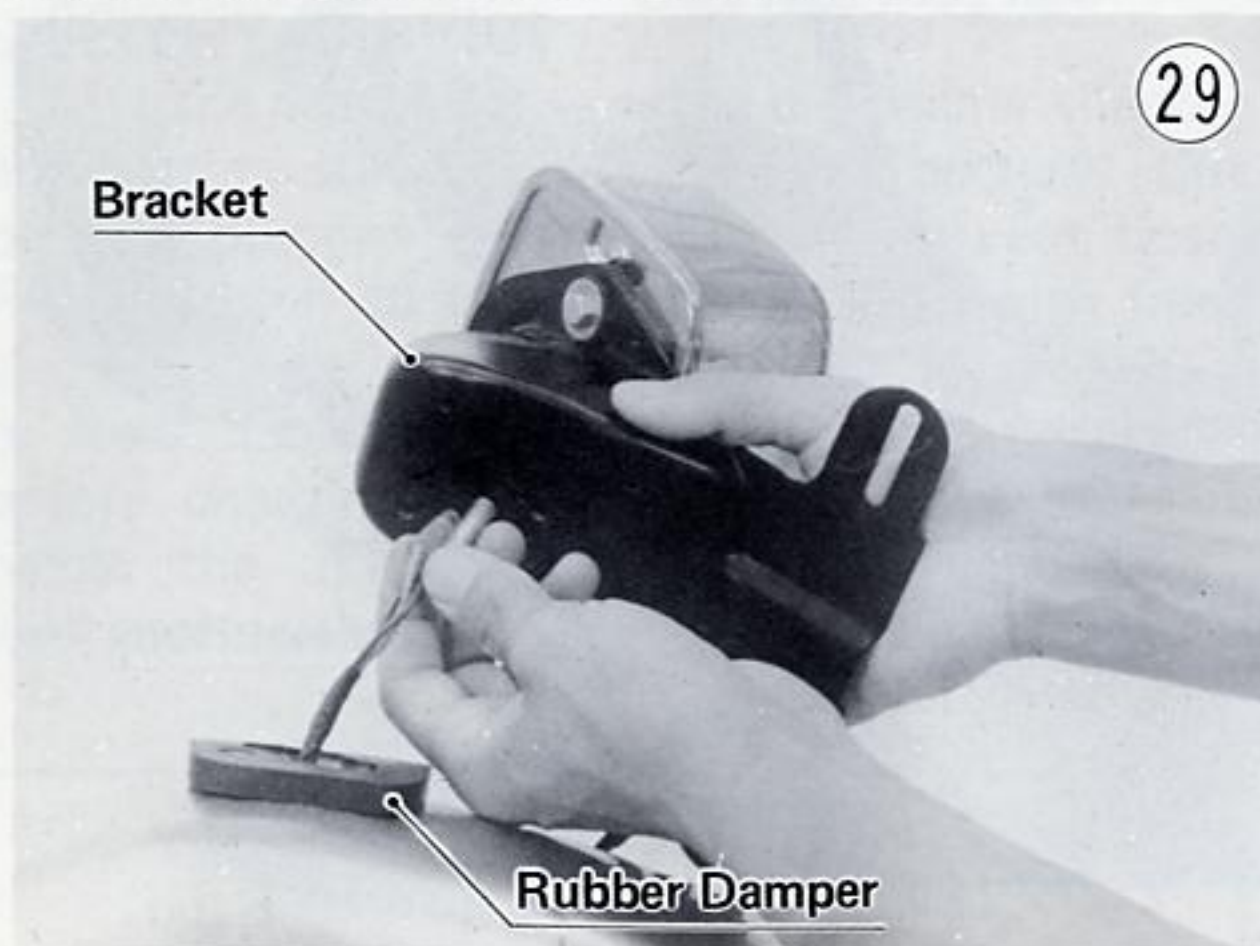

Mount the taillight to the fender by inserting the three bolts, each with a flat rubber damper, large flat washer, and lockwasher. Being careful not to deform the rubber dampers, tighten the bolts securely.



Connect the taillight wires according to the color codes.



**REAR FENDER**

Remove the seat back rest which is temporarily installed. Slide the rear fender into place. Insert

the two bolts, lockwashers, and large flat washers into the fender. Do not tighten the bolts yet. **NOTE:** Make sure to place the wire clip on the right side bolt.

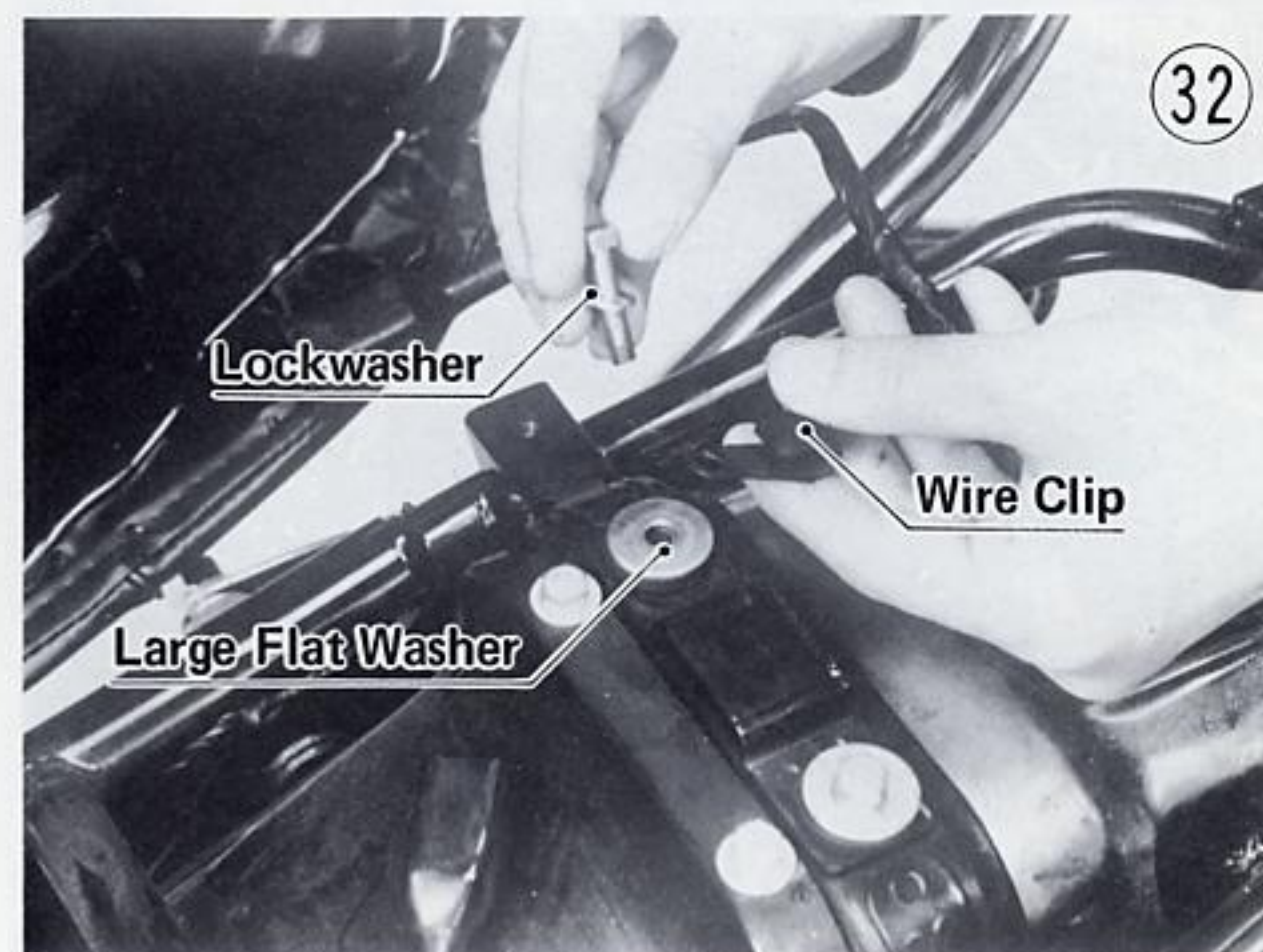

Insert the four bolts, lockwashers, and flat washers into the bracket and fender. Tighten all the fender mounting bolts securely.

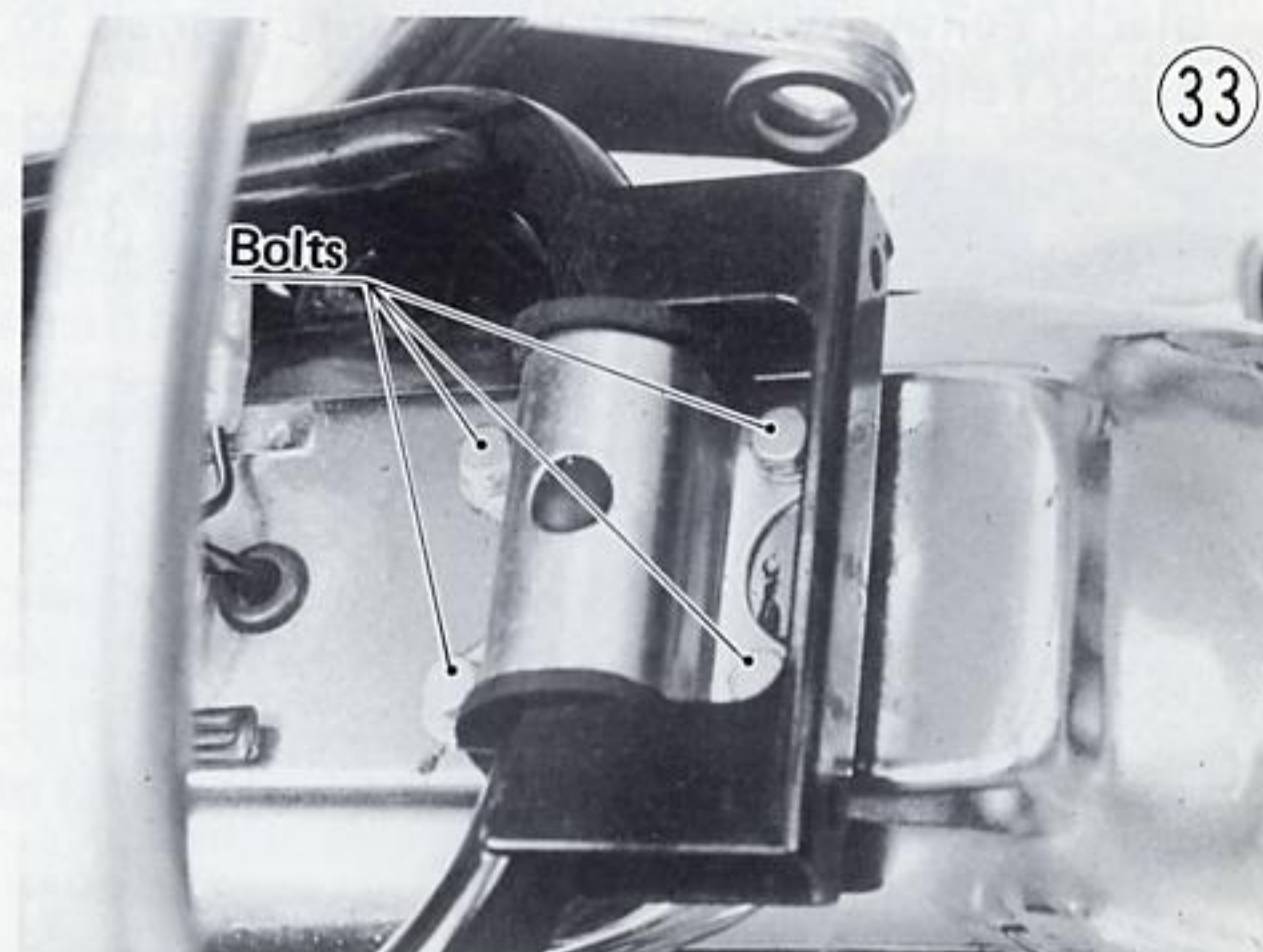

**REAR TURN SIGNALS**

Fit the rubber dampers and cup washers into the holes in the turn signal mounting bracket.

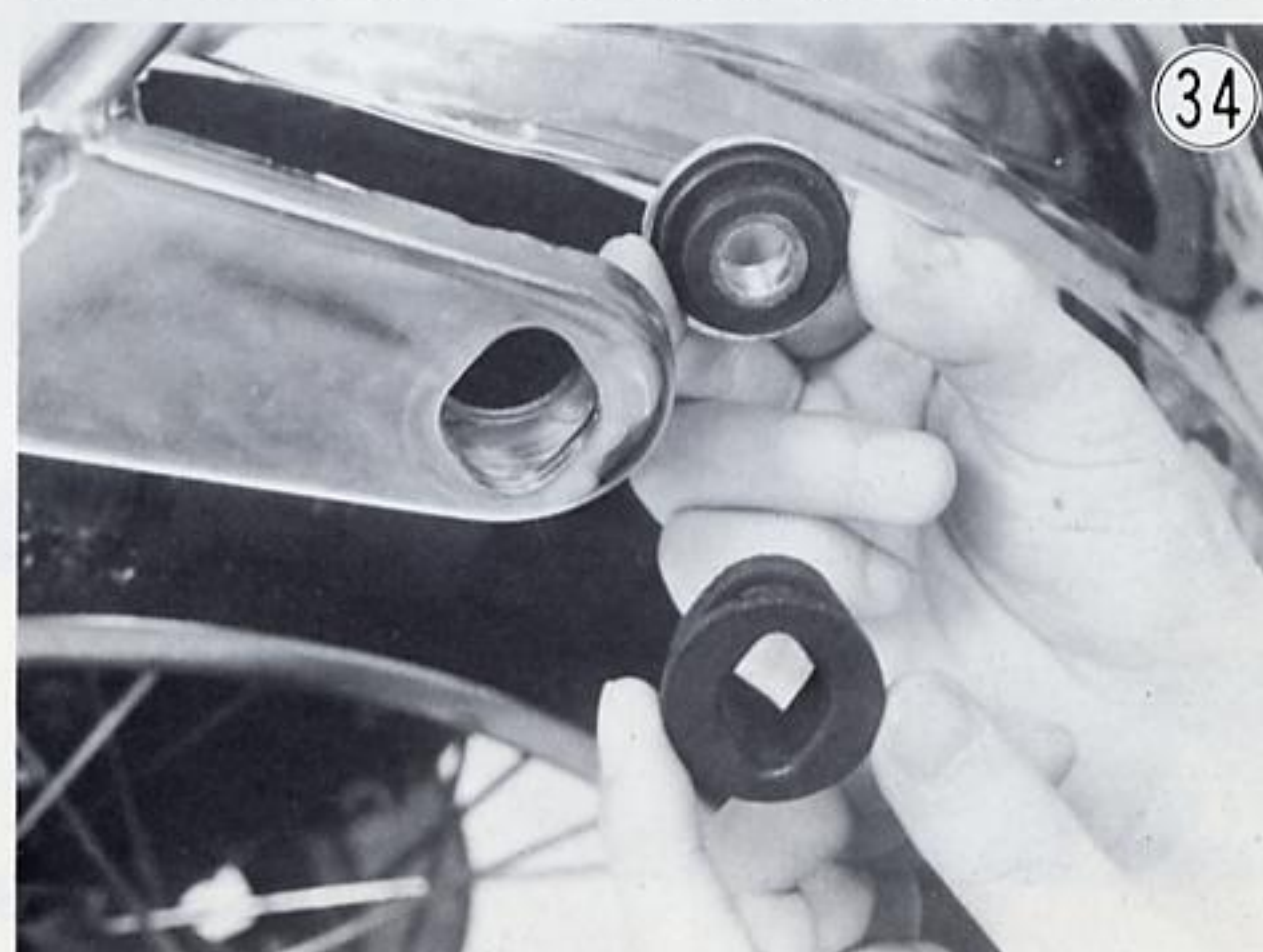

Slip the rear turn signals into place and fasten them each with a ground wire, large flat washer,



## 10 ASSEMBLY

lockwasher, and nut. Be sure the turn signals are pointing to the rear, and tighten the nuts securely.

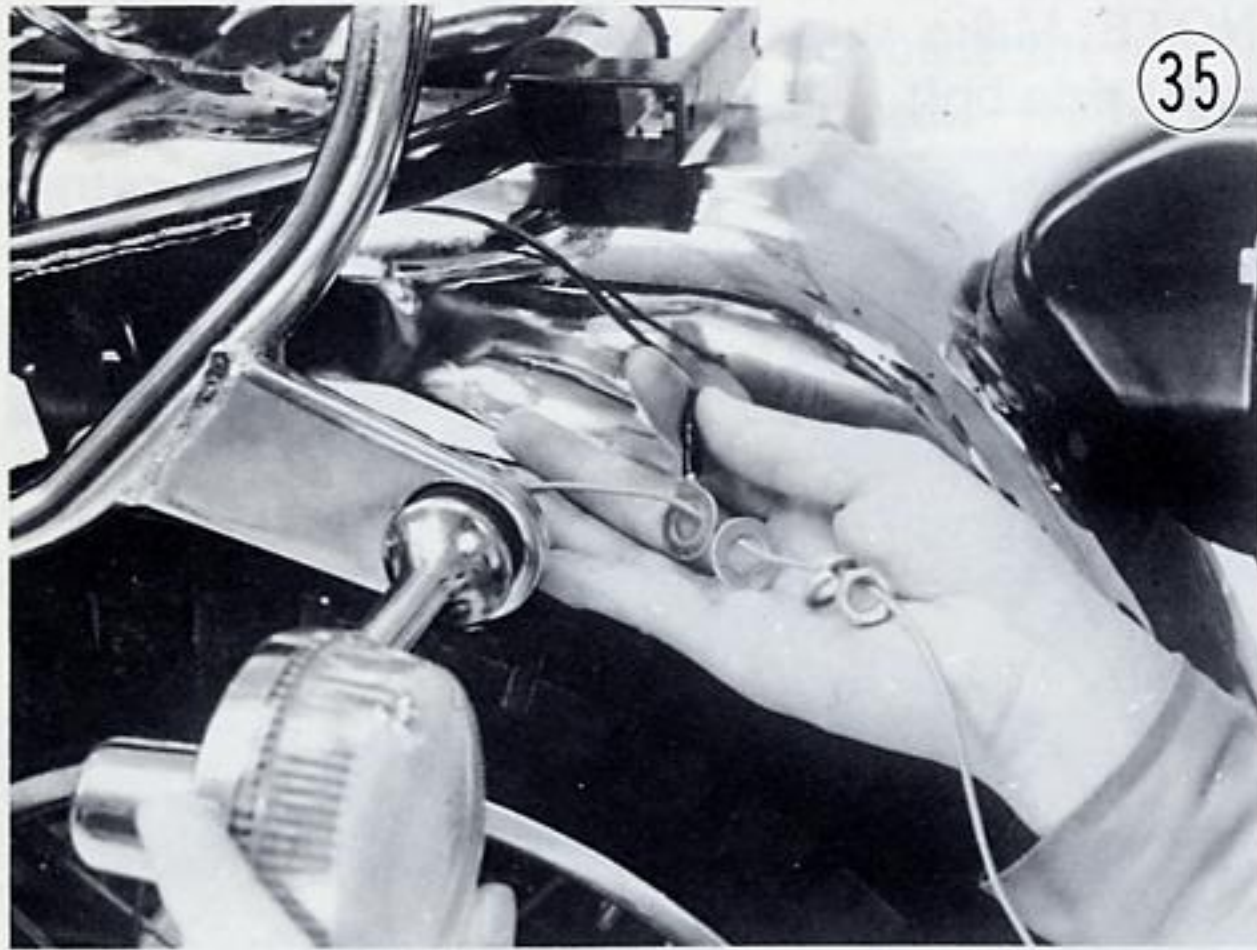

Connect the turn signal wires according to the color codes, and secure them with the wire clips on the fender.

Gray wire from right turn signal to Gray  
Gray wire from left turn signal to Green  
Black/Yellow wires from both turn signals to Black/Yellow

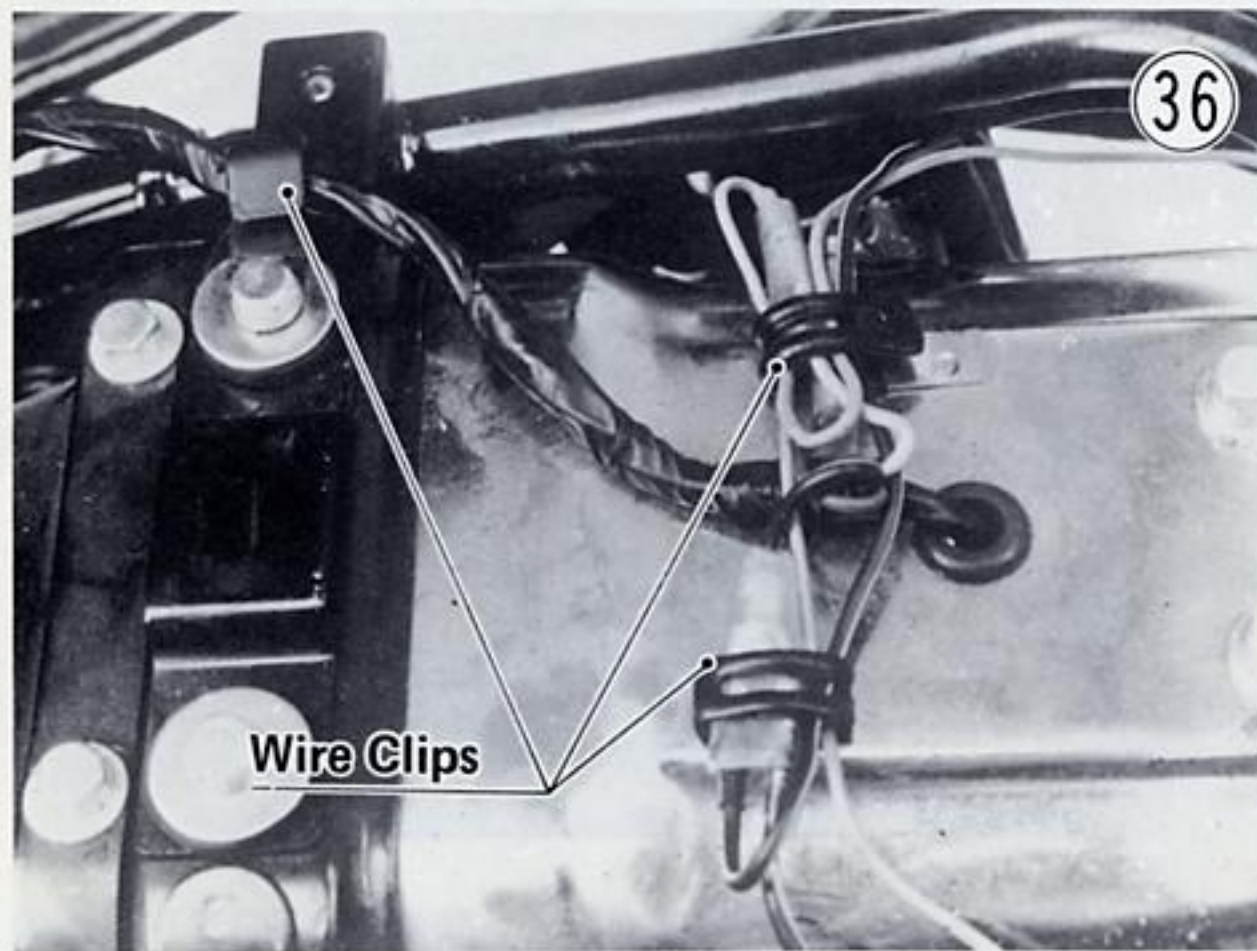

Connect the main electrical plug from the rear section.



### SEAT BACK REST

Install the seat back rest using the four bolts,

lockwashers, and three large flat washers. Mount the helmet hook on the left front bolt.

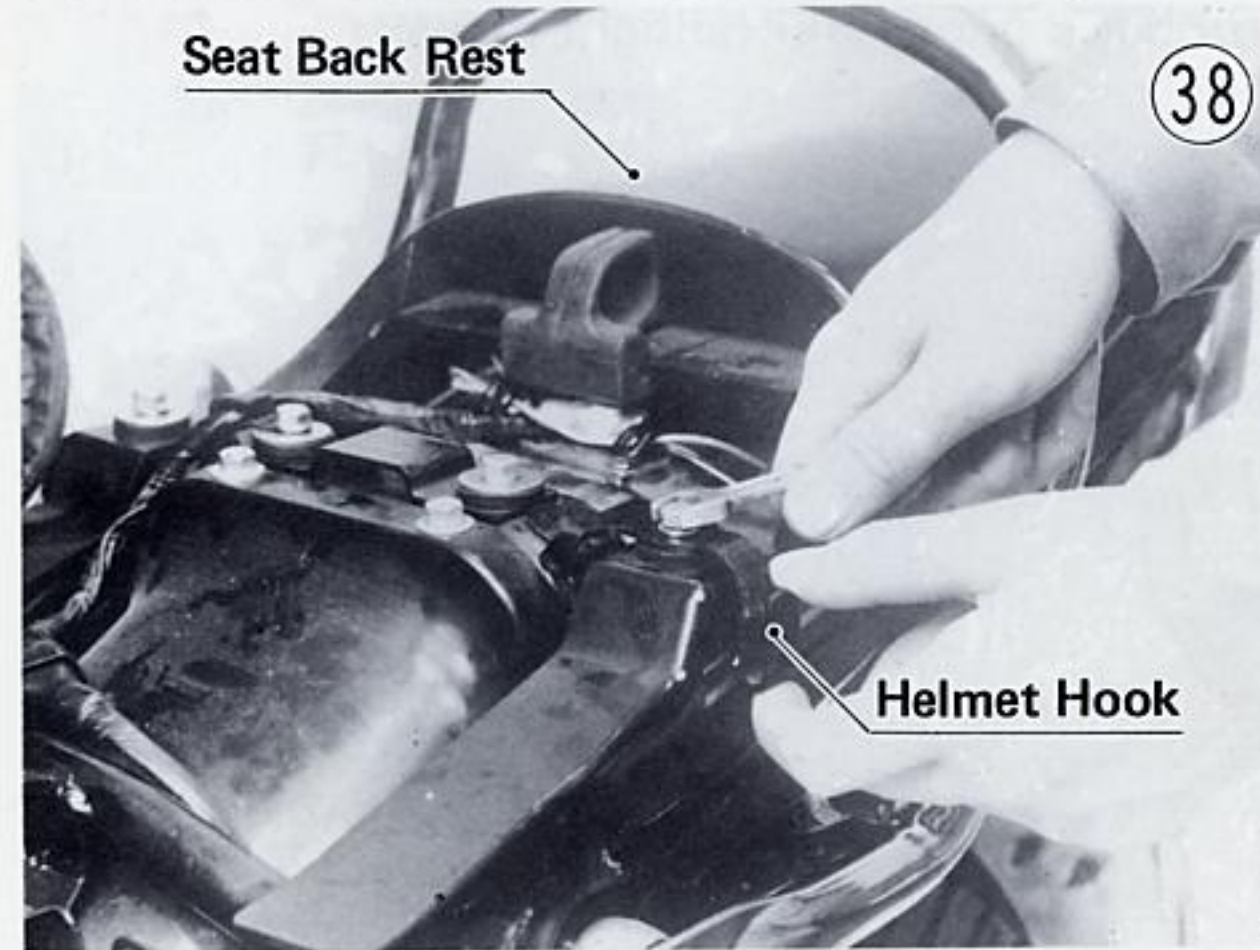

### CLEAN BRAKE DISCS

Clean the brake discs on the front and rear, using trichloroethylene or another oilless solvent.

**WARNING** If not cleaned, the anticorrosive treatment applied to the brake disc surface will interfere with brake action, and an unsafe riding condition could result.

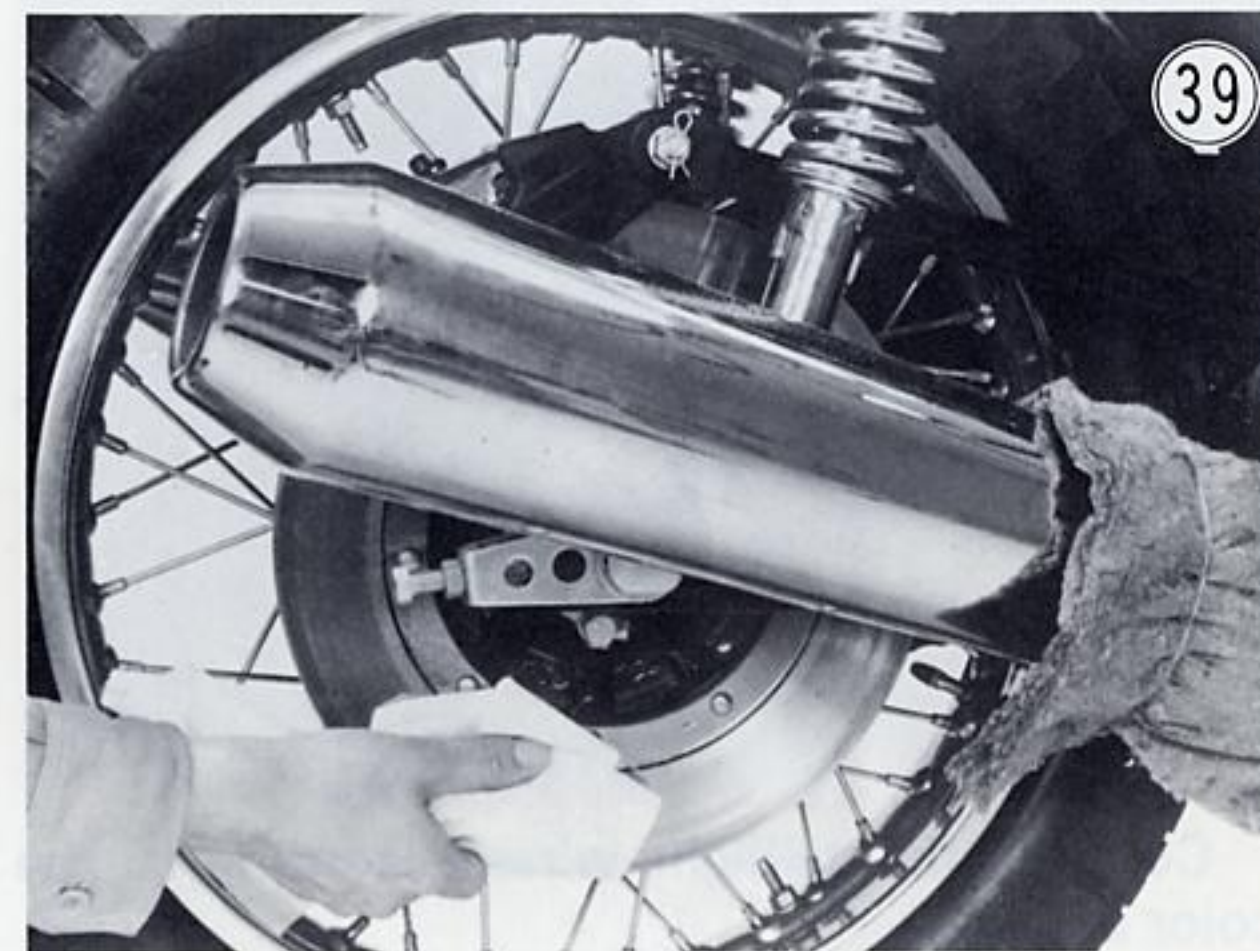

Remove the protective coverings and rubber bands from the motorcycle. Wipe off all dust and dirt.



ASSEMBLY COMPLETELY



# Preparation

## BATTERY SERVICE

Lift the seat. Remove the air cleaner silencer and battery stay, and pull out the battery. Cut off the plugged end of the battery vent hose. Fill each cell to the upper level line with fresh electrolyte at a temperature of 30°C (86°F) or less. Let the battery stand for 30 minutes before charging. If the electrolyte level drops below the upper level line, refill the battery with more electrolyte before charging.

### POISON/DANGER CAUSES SEVERE BURNS

Contains sulfuric acid. Avoid contact with skin, eyes or clothing. Antidote:

EXTERNAL- Flush with water.

INTERNAL- Drink large quantities water or milk. Follow with milk of magnesia, beaten egg or veg. oil. Call physician immediately. Eyes: Flush with water for 15 minutes and get prompt medical attention. Batteries produce explosive gases. Keep sparks, flame, cigarettes away. Ventilate when charging or using in enclosed space. Always shield eyes when working near batteries.

**KEEP OUT OF REACH  
OF CHILDREN**



Apply a light coat of grease to the battery terminals to prevent corrosion. Be sure the battery caps are tight, and install the battery in the battery case. Route the battery vent hose according to the CAUTION LABEL under the seat. Connect first the positive lead and then the negative. Slide down the rubber boot. Make sure the rubber dampers are properly in place, and install the battery stay. Install the air cleaner silencer.

**WARNING** Route the battery vent hose away from the muffler and chain. Make sure it is not folded or pinched. Corrosive fumes can damage the motorcycle or cause the battery to explode, if trapped.

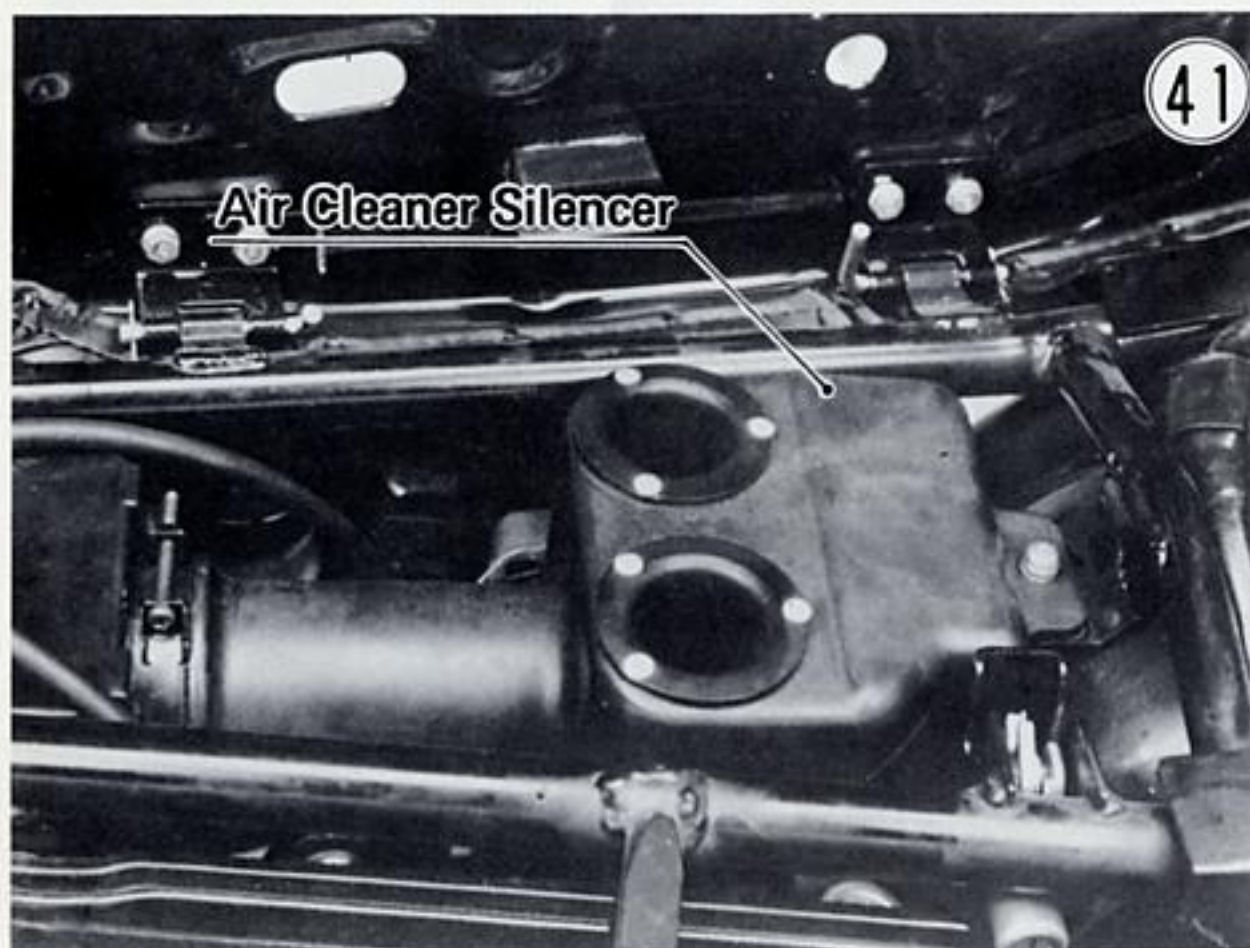

An initial charging is necessary before placing the battery in service. Connect the battery charger leads (red to +, black to -) to the battery posts. Remove the battery caps. Charge for 10 hours at no more than 1.4 amps. Stop charging if the electrolyte temperature rises above 45°C (113°F). If the fluid level drops, refill the battery with distilled water only. Wash off any spilled acid with fresh water.

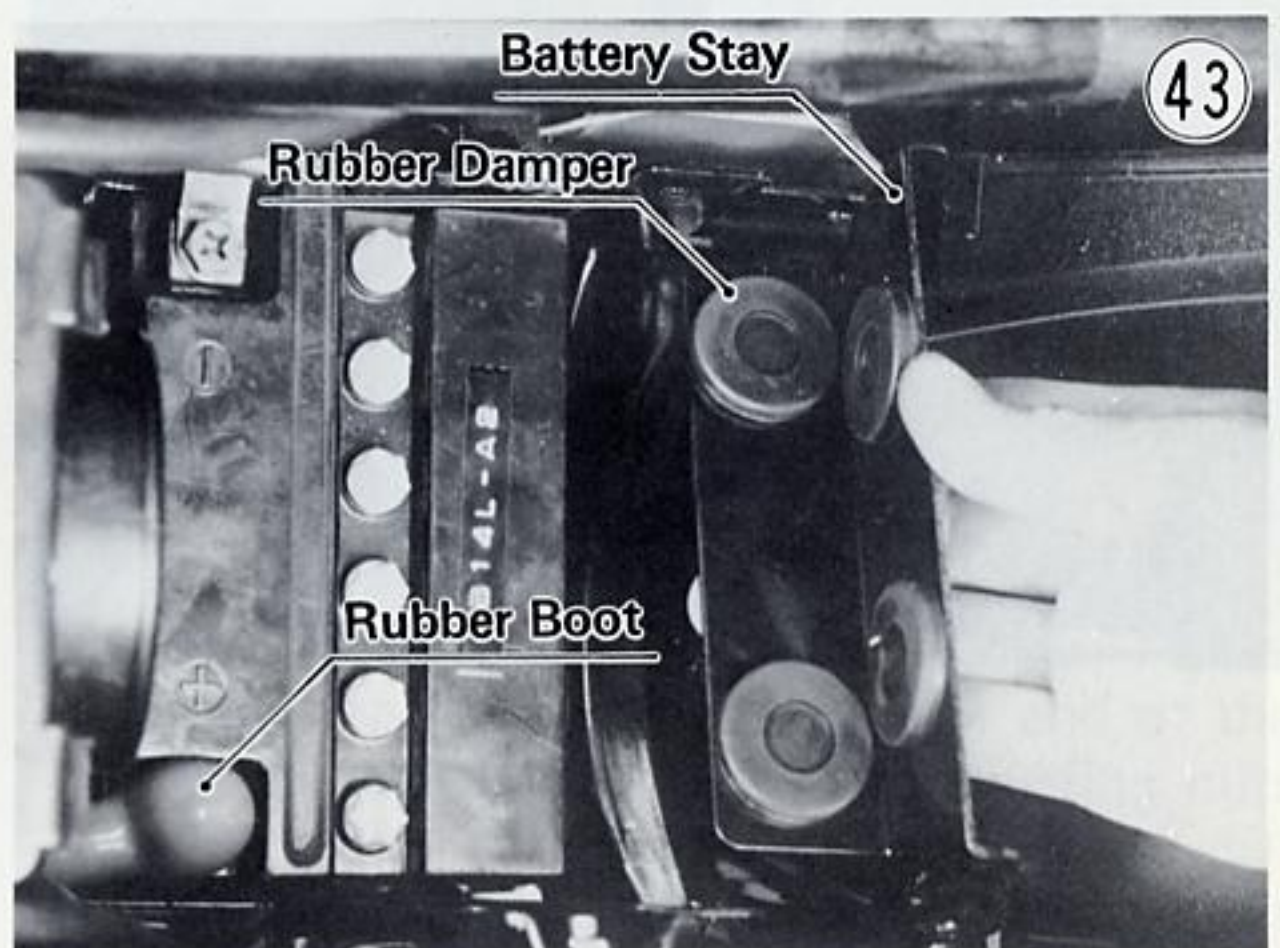

## ENGINE OIL

With the motorcycle on its center stand, remove the sump and oil filter drain plugs, and drain the shipping oil from the engine.



## 12 PREPARATION

Reinstall the drain plugs with their gaskets, and tighten them securely.

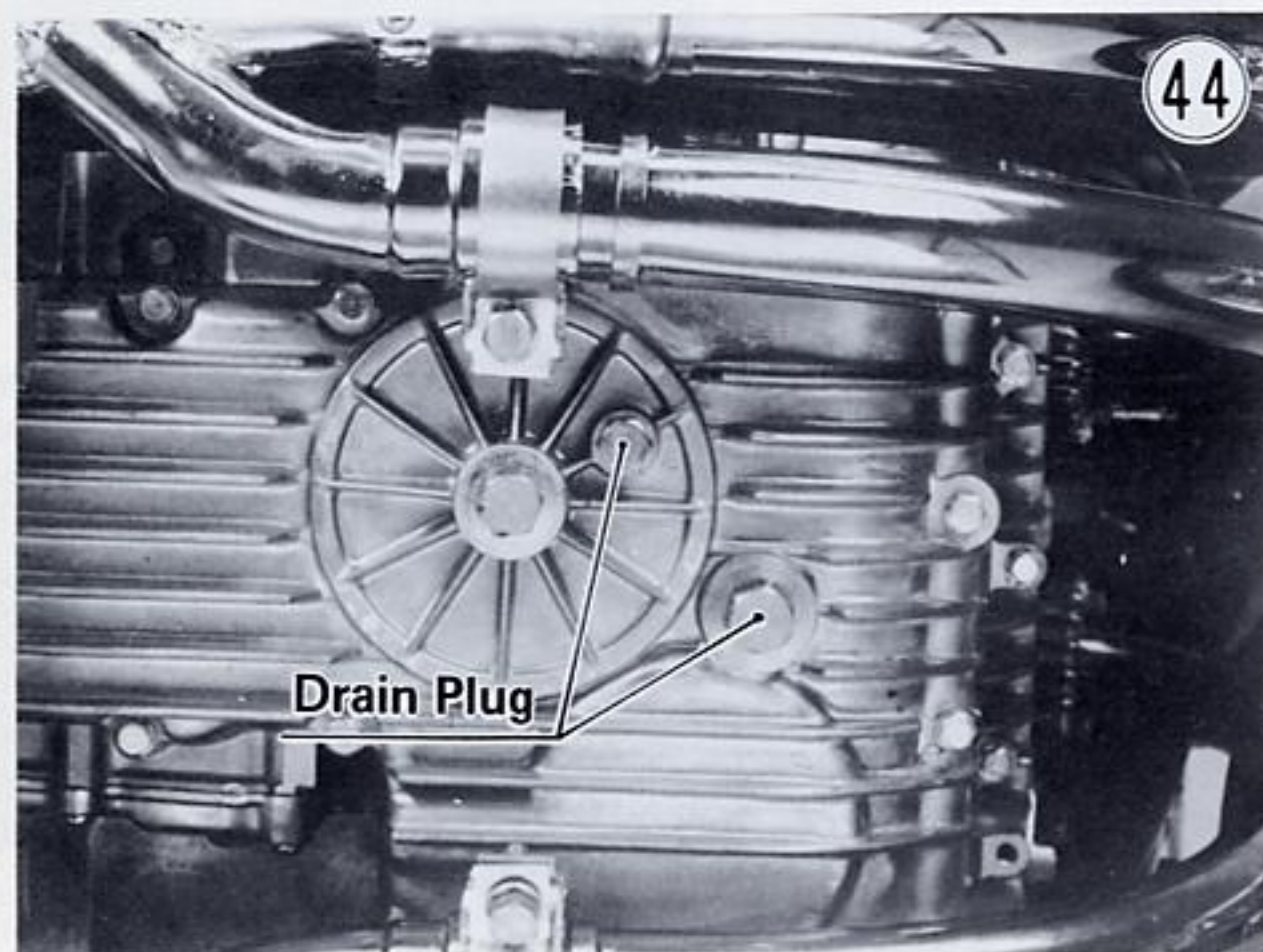

Remove the oil filler plug, and fill the engine with 3.0 liters (2.64 Imp qt) of SAE 10W40, 20W50, or 10W50 motor oil marked SE. The oil should come between the two level lines next to the oil level gauge when the motorcycle is held vertical. Be sure the O ring is in place on the filler plug, and reinstall the filler plug.

**NOTE:** It is recommended to check the oil level again after the engine is thoroughly warmed up.

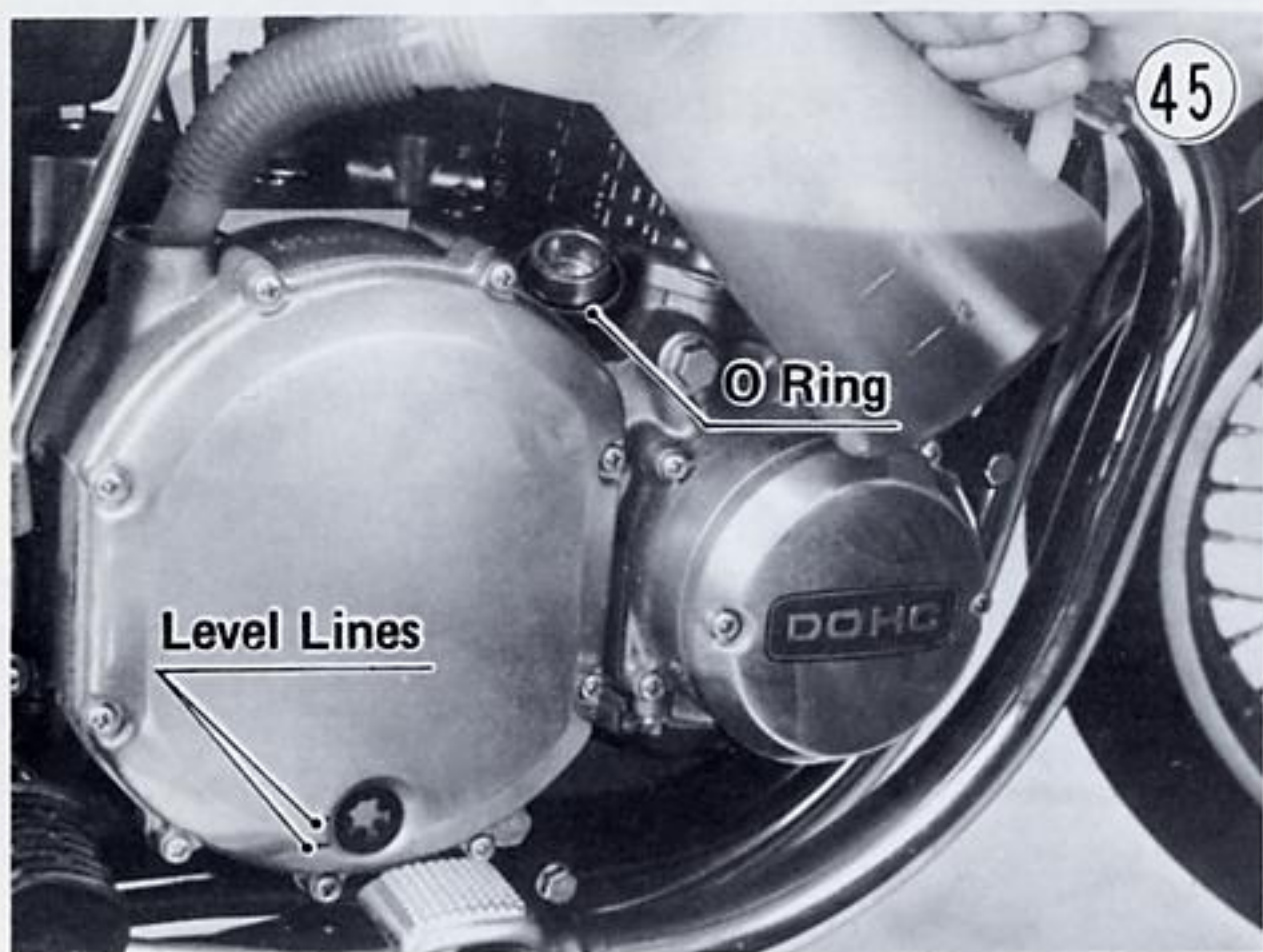

### FUEL TAP

Turn the fuel tap "off". Remove the fuel tap sediment cup, gasket, and filter. Clean any foreign matter out of the cup and filter, and reassemble the fuel tap. If excessive sediment exists, remove the fuel tank and clean it thoroughly.

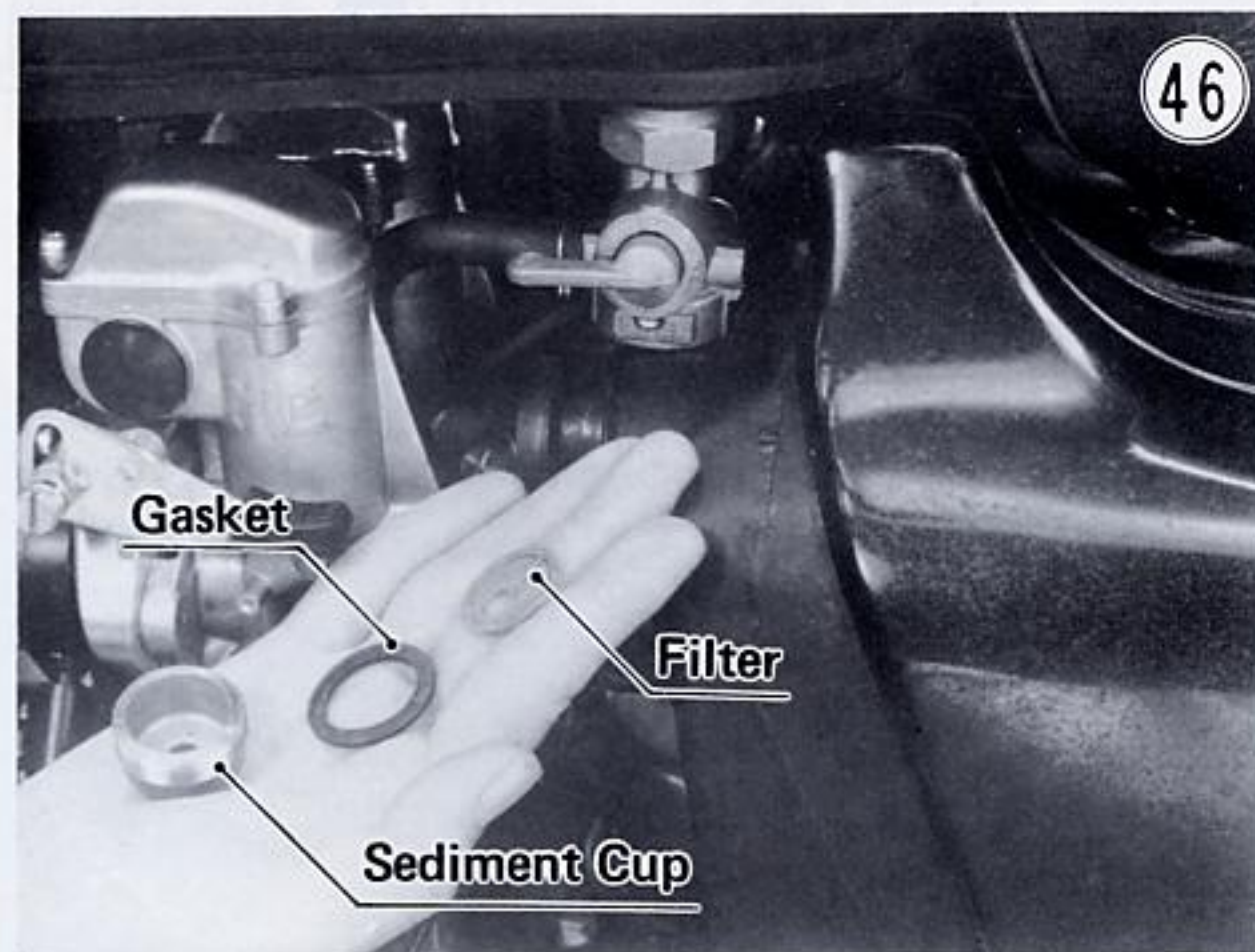

### CLUTCH ADJUSTMENT

1. Remove the clutch adjusting cover. If the adjusting screw is not loose enough, back it out at this time.
2. Loosen the knurled locknut at the clutch lever, and turn the adjuster to make a 5~6 mm gap between the adjuster and locknut.

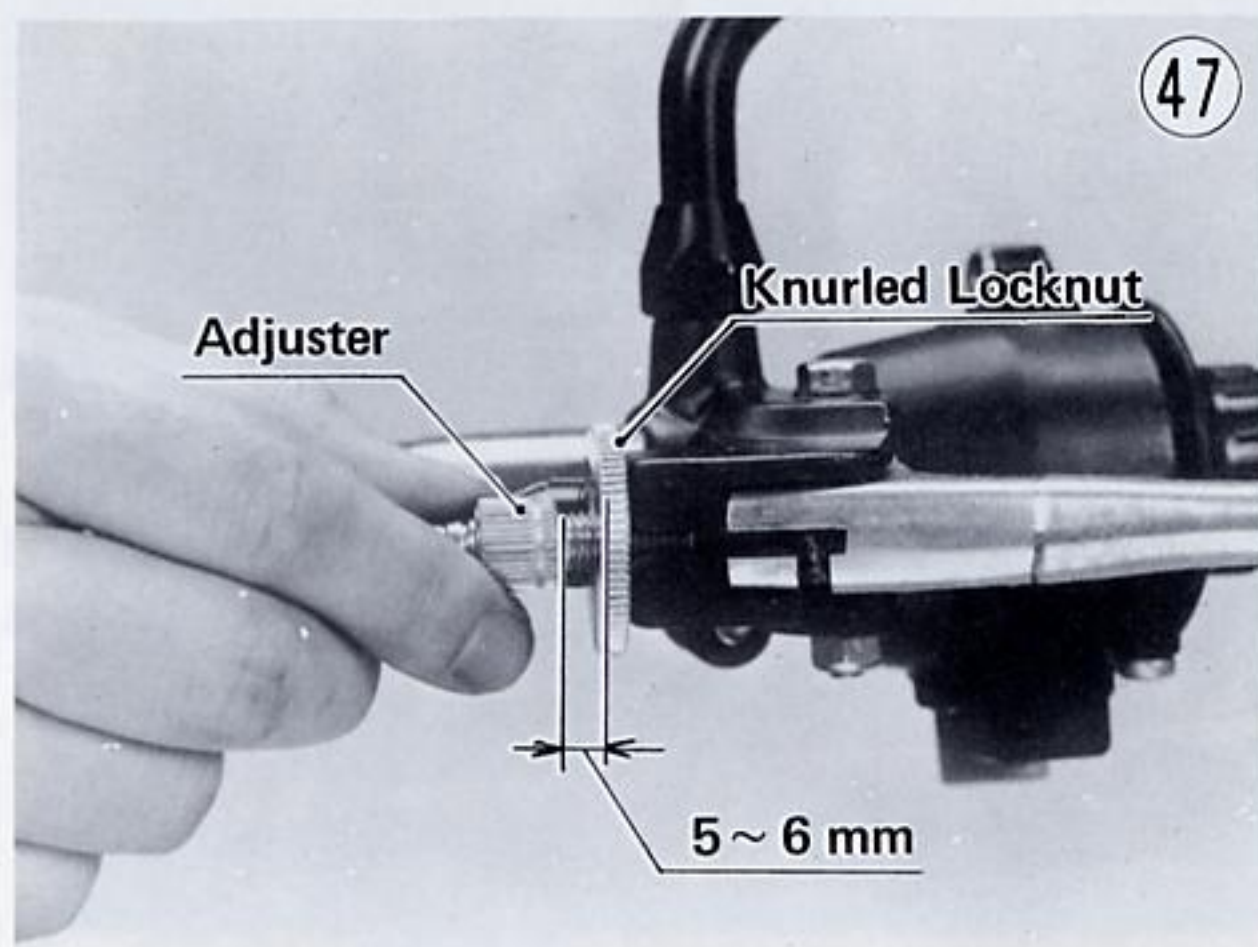

3. Turn the adjusting screw in until it seats lightly. This is the point where the clutch is just starting to release. Back out the adjusting screw 1/2 turn from that point and tighten the locknut.
4. Take up all the clutch cable play by turning the adjusting nut at the middle of the cable. Tighten the locknut.



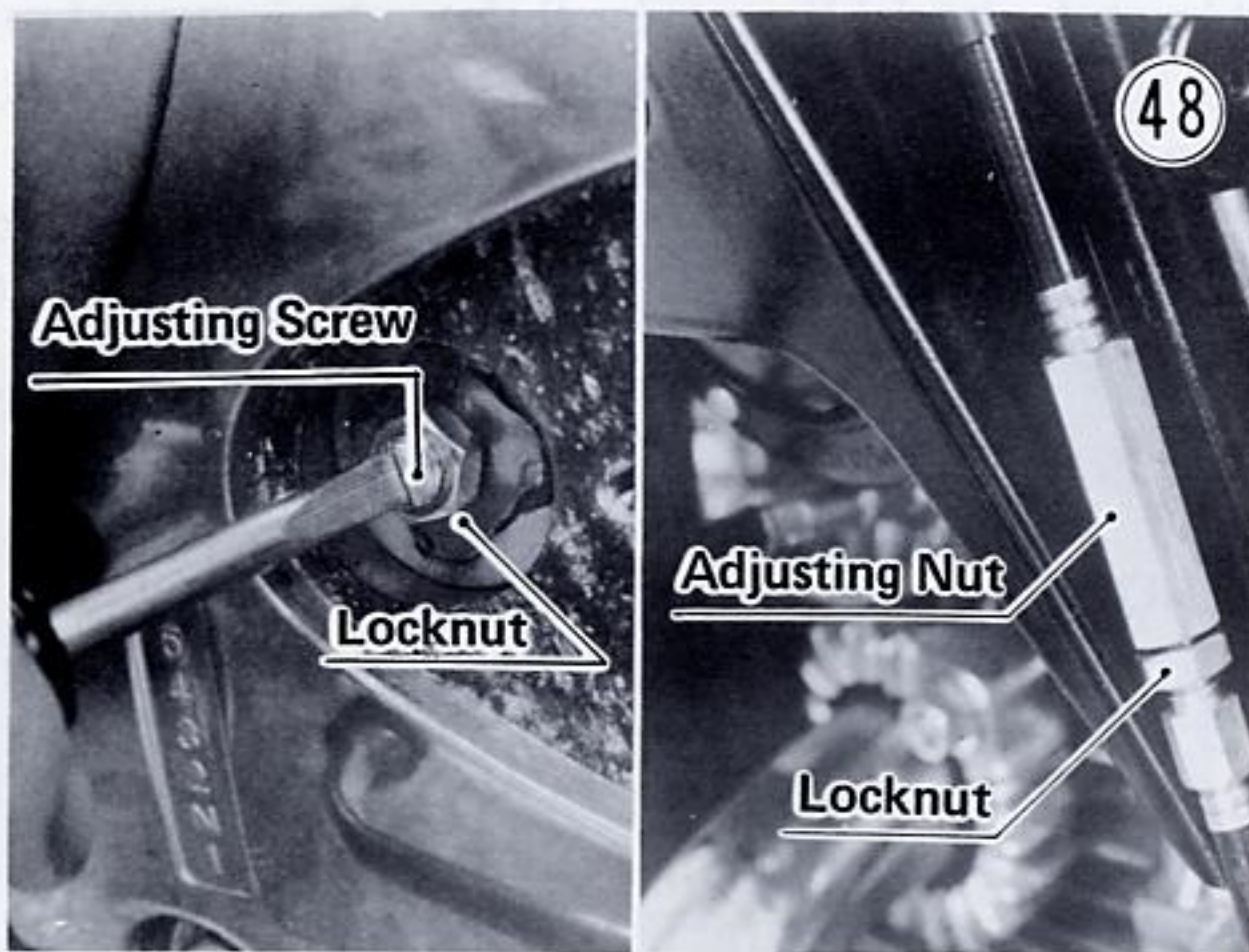

5. Turn the adjuster at the clutch lever until the clutch lever has 2~3 mm of play and tighten the knurled locknut.

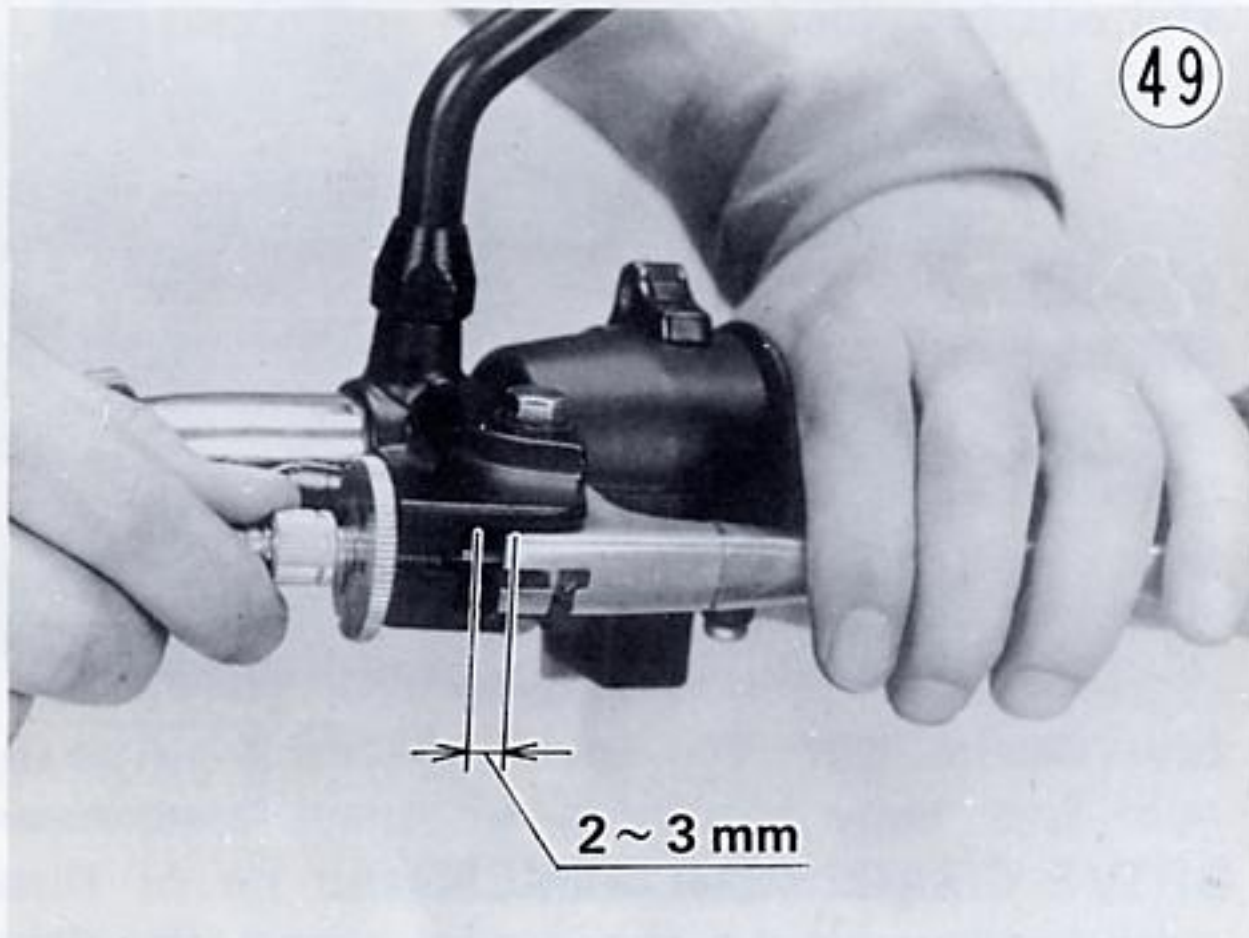

6. Make sure all outer cable ends are seated in their fittings. Reinstall the clutch adjusting cover.

**WARNING** If the clutch cable is not fully seated in its fittings, it could slip into place later, and the clutch would not disengage.

### THROTTLE CABLE ADJUSTMENT

Check that the throttle grip has 2~3 mm of play and turns smoothly. Also check that the outer ends of the throttle cables are seated properly in the adjusting nuts.

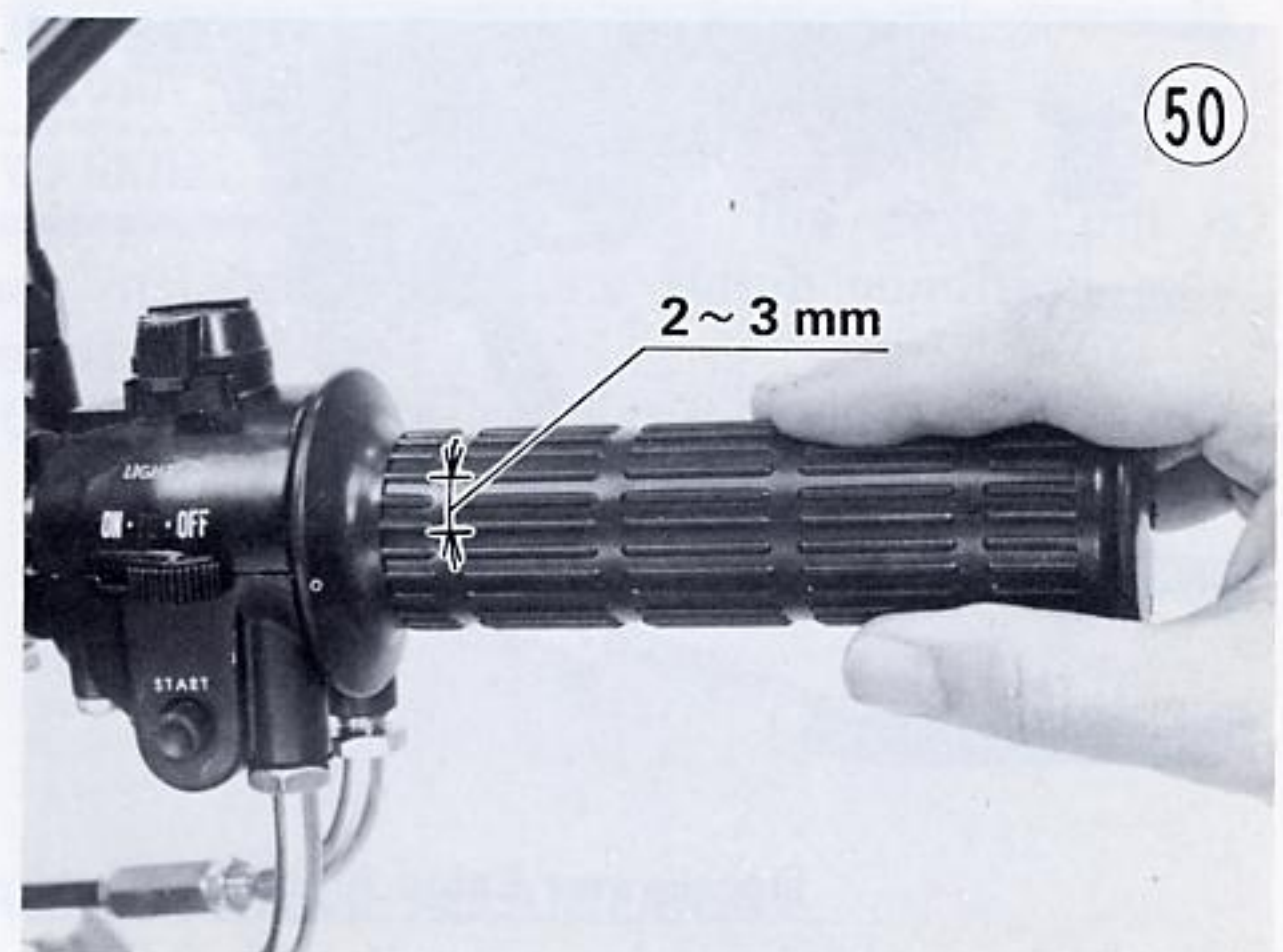

Next, push the throttle grip closed. At this time, there should be no clearance between the cable bracket and the stopper on the pulley.

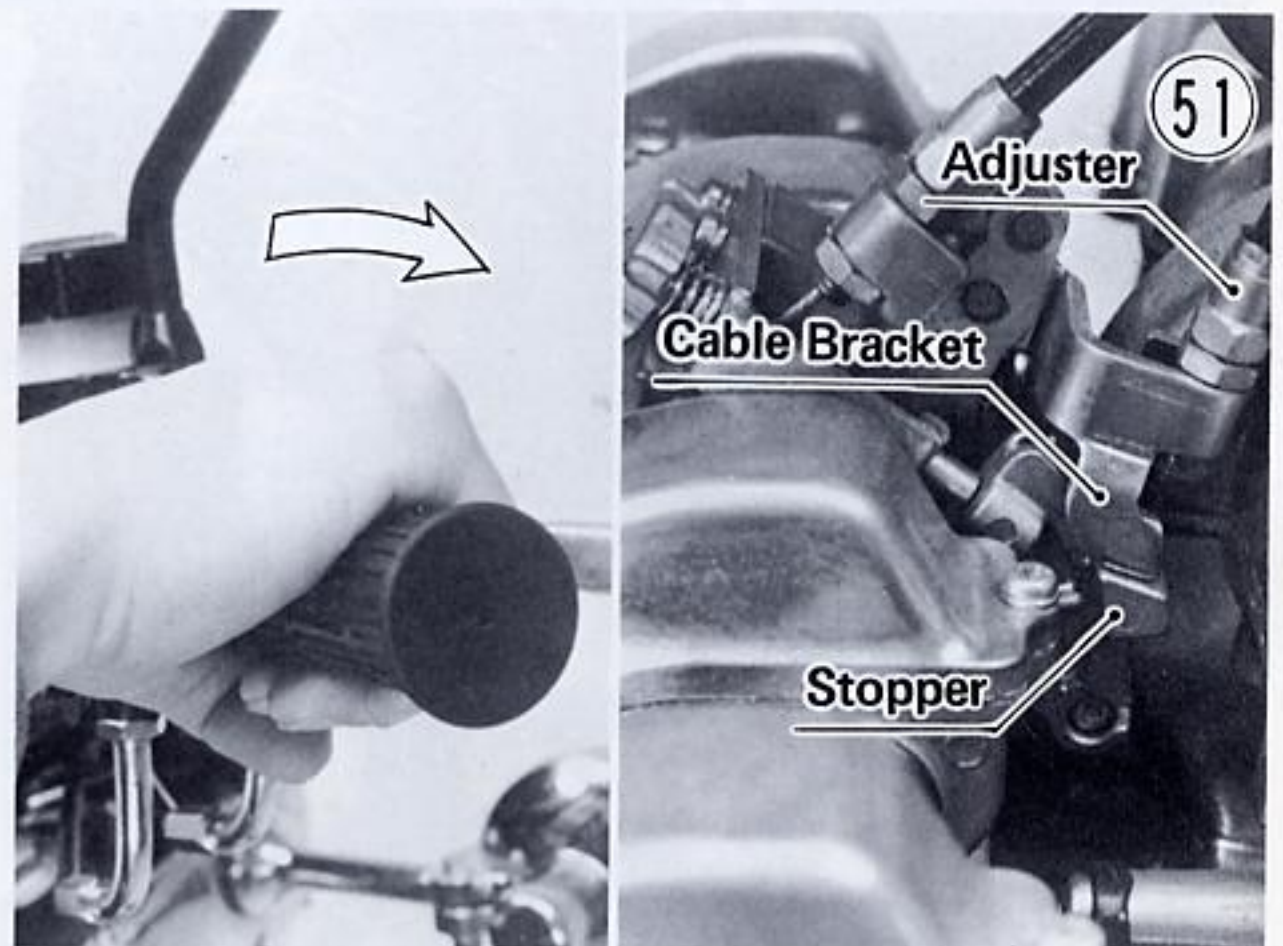

If adjustment is necessary, carry out the following.

1. Loosen the locknuts at the upper end of the throttle cables, and turn the adjusting nuts all the way in to assure plenty of play.
2. Turn out the decelerator cable adjusting nut until the clearance between the cable bracket and the stopper is eliminated, when the throttle grip is completely closed.
3. Turn out the accelerator cable adjusting nut until the throttle grip has the correct amount of play.
4. Tighten both locknuts securely.

**NOTE:** If necessary, use the adjusters at the lower ends of the throttle cables.



## 14 PREPARATION

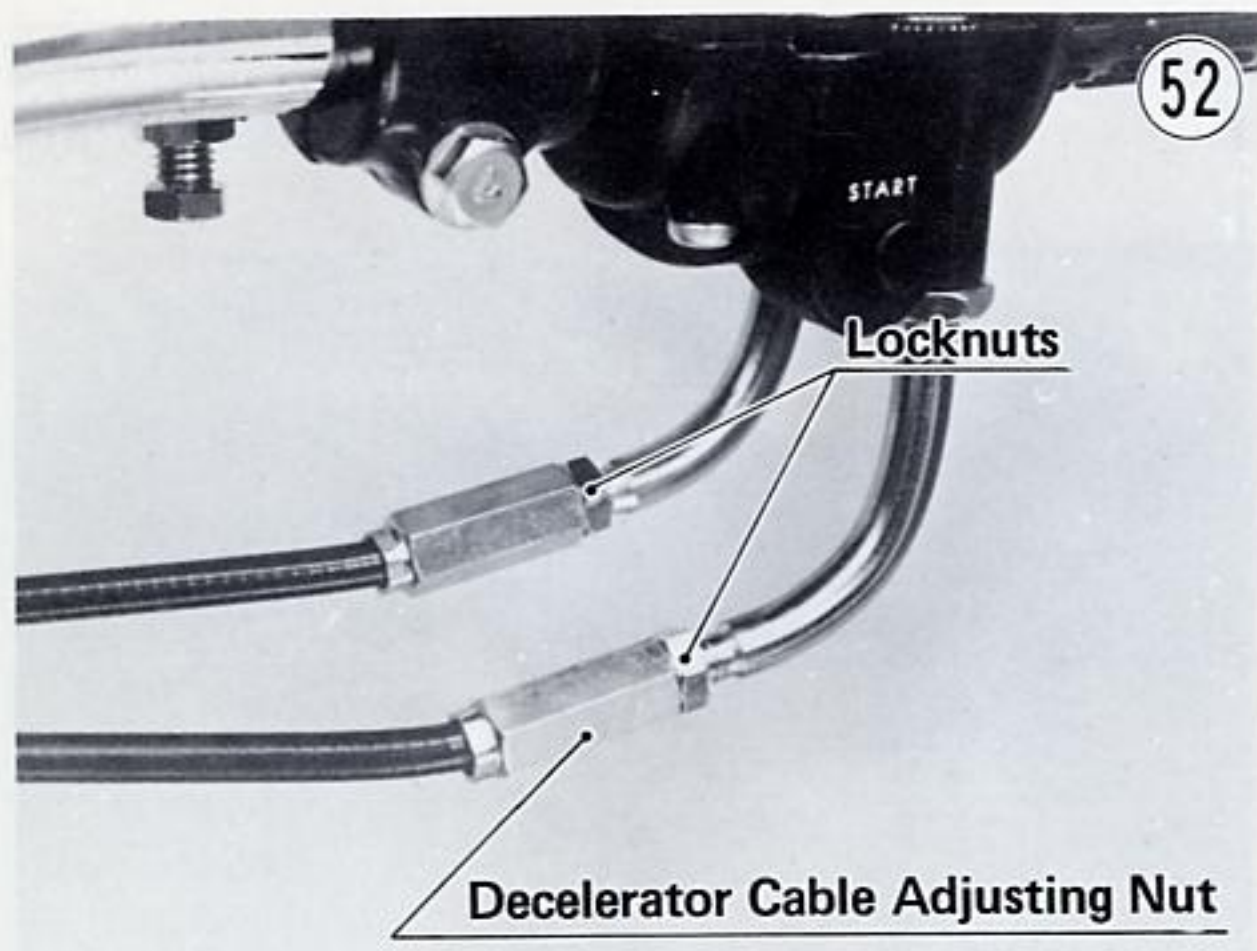

### BRAKE FLUID CHECK

Check the brake fluid in both brake master cylinder reservoirs with the reservoir held as nearly level as possible. If the fluid is below the level line on the front reservoir, or below the upper level line on the rear reservoir, fill it with brake fluid marked "D.O.T.3" only. Check the Owner's Manual for recommended brands.

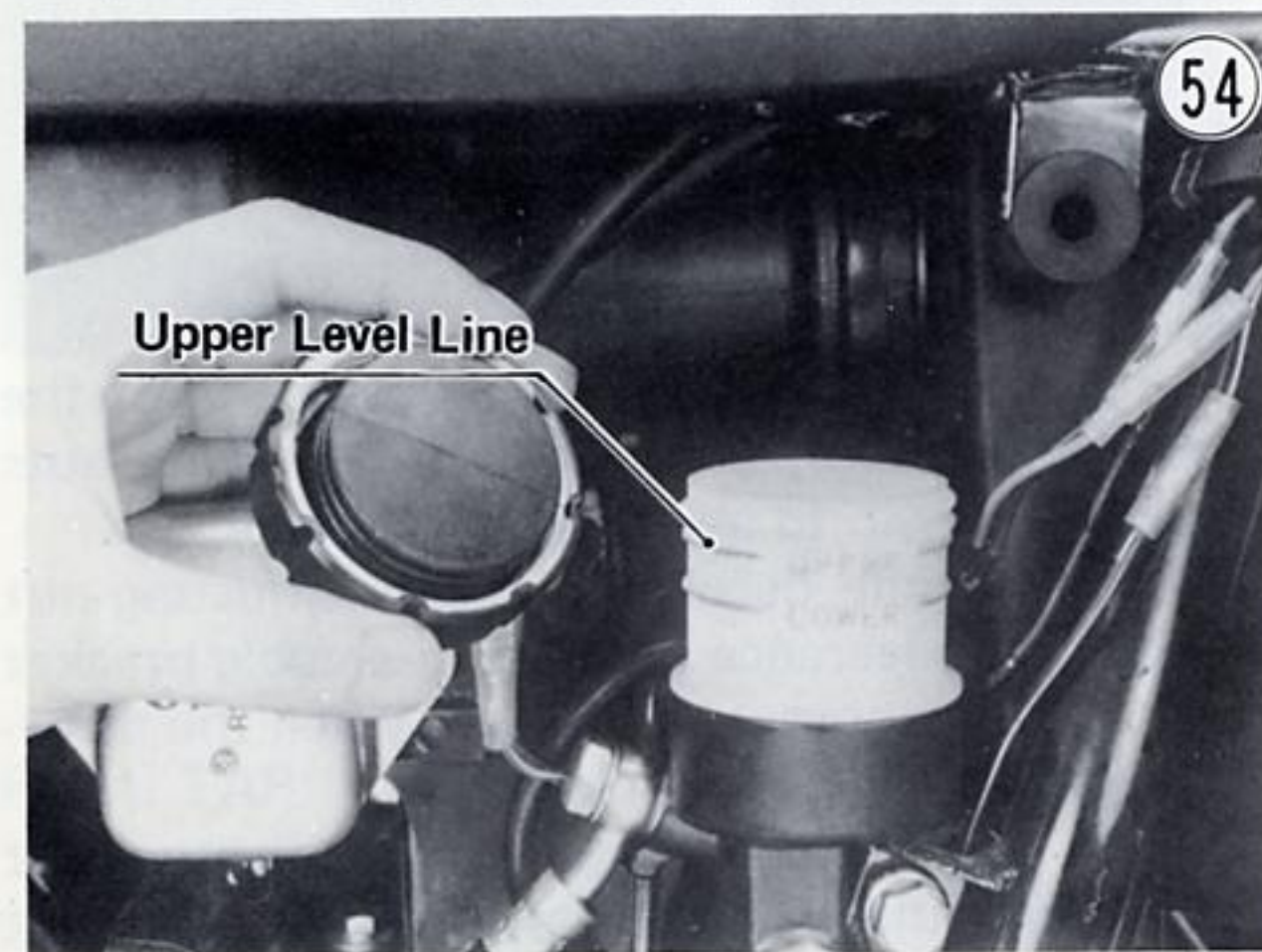
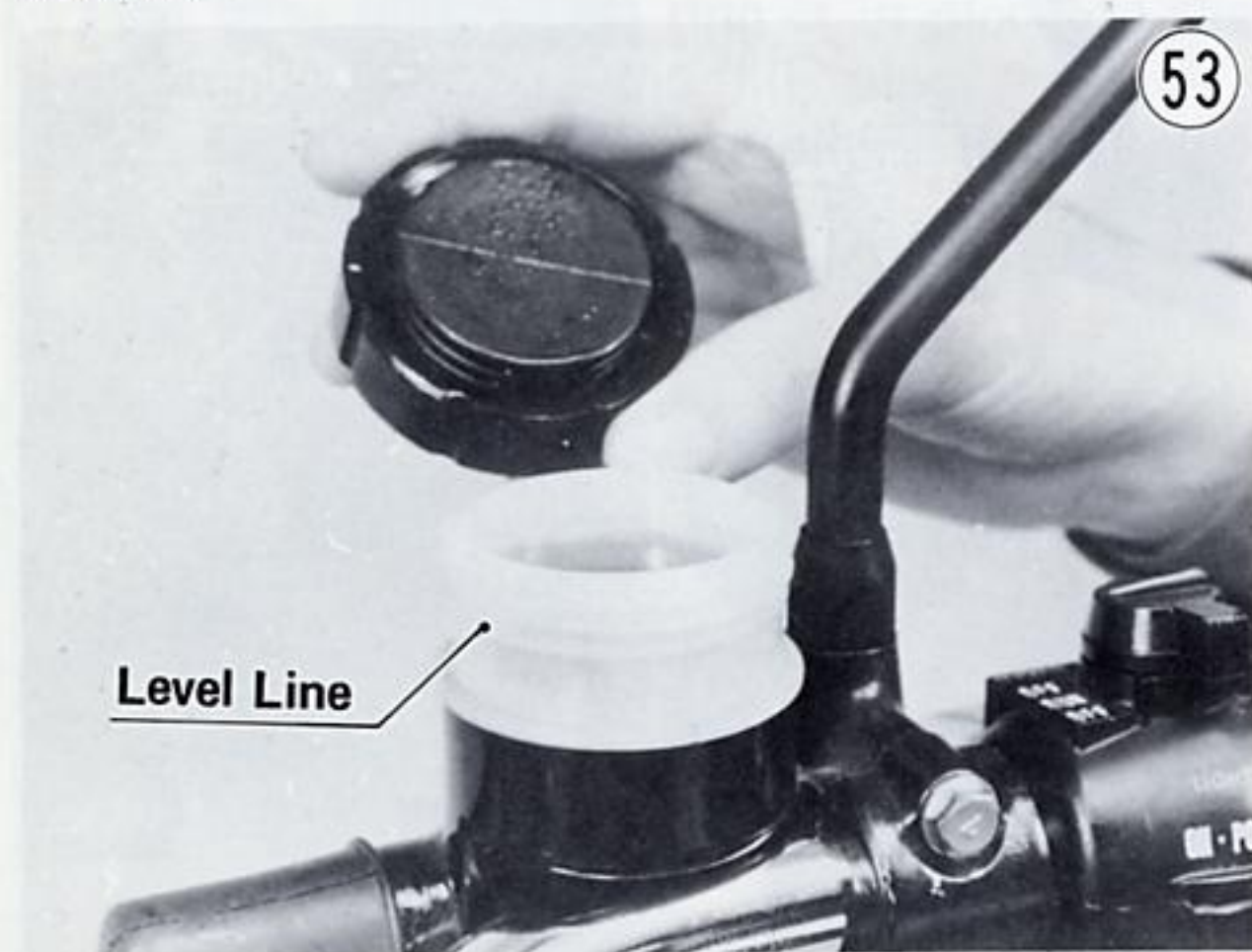

Depress the front brake lever and rear brake pedal several times. If it feels spongy, there might be air in the brake line. In this case,

bleed the brake line according to the instructions in the Shop Manual. Also check for fluid leakage around the fittings.

**CAUTION** Brake fluid quickly ruins painted surfaces; any spilled fluid should be wiped up immediately.

### FRONT BRAKE ADJUSTMENT

Check that the front brake lever play is 3 ~ 5 mm. If it is not, first straighten the part of the washer that is bent over the side of the locknut. Loosen the locknut, and turn the adjusting bolt a fraction of a turn so that the brake lever has the proper amount of play. Tighten the locknut with 2 kg-m (14.5 ft-lbs) of torque, and bend back the washer.

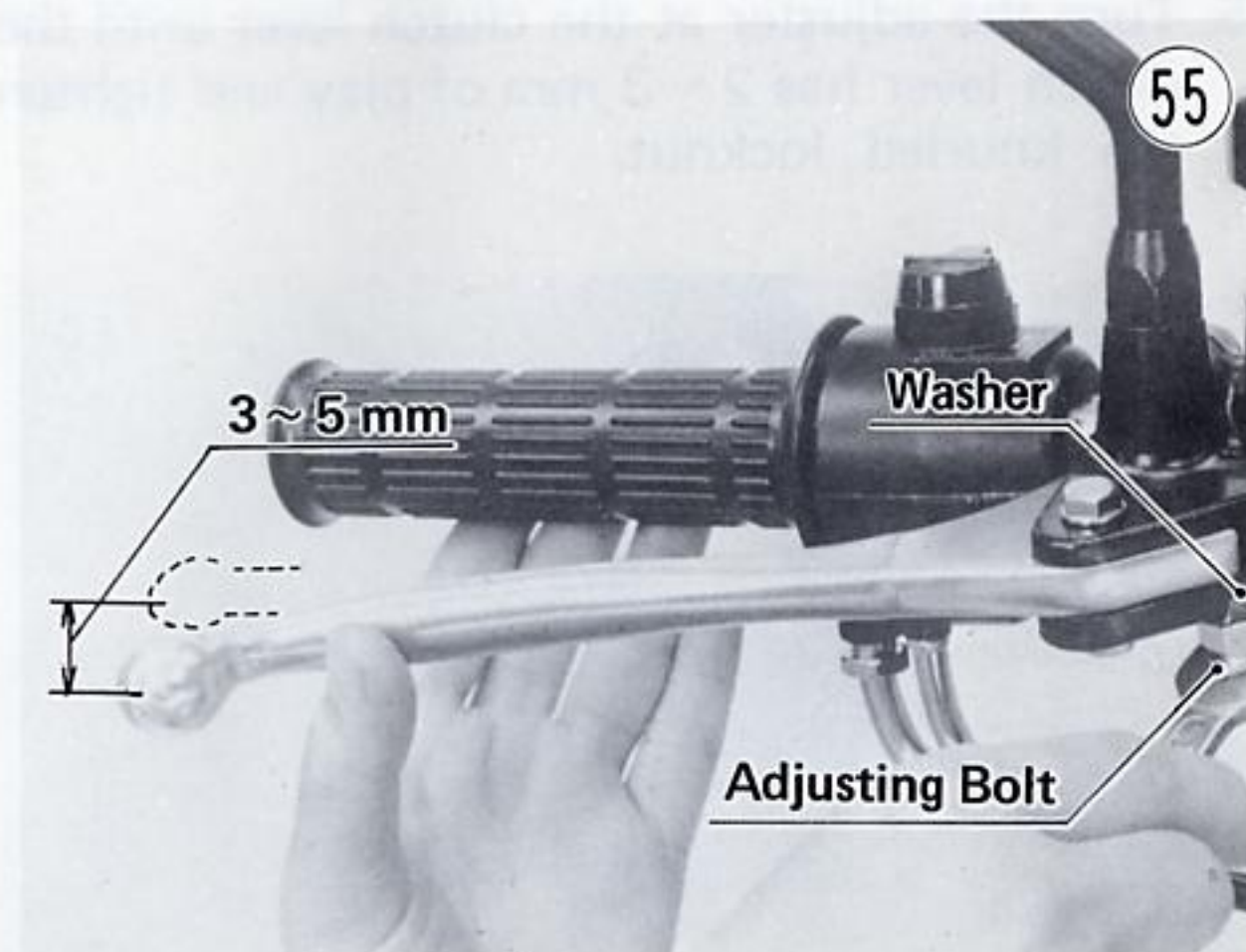

### DRIVE CHAIN ADJUSTMENT

With the unit on the center stand, the drive chain should have 30 ~ 35 mm of play in the middle of the lower run. Also, check that the left and right chain adjusters are positioned at corresponding marks on the swing arm tabs, indicating proper wheel alignment. If the drive chain requires adjustment, or if the wheel needs aligning, carry out the following.

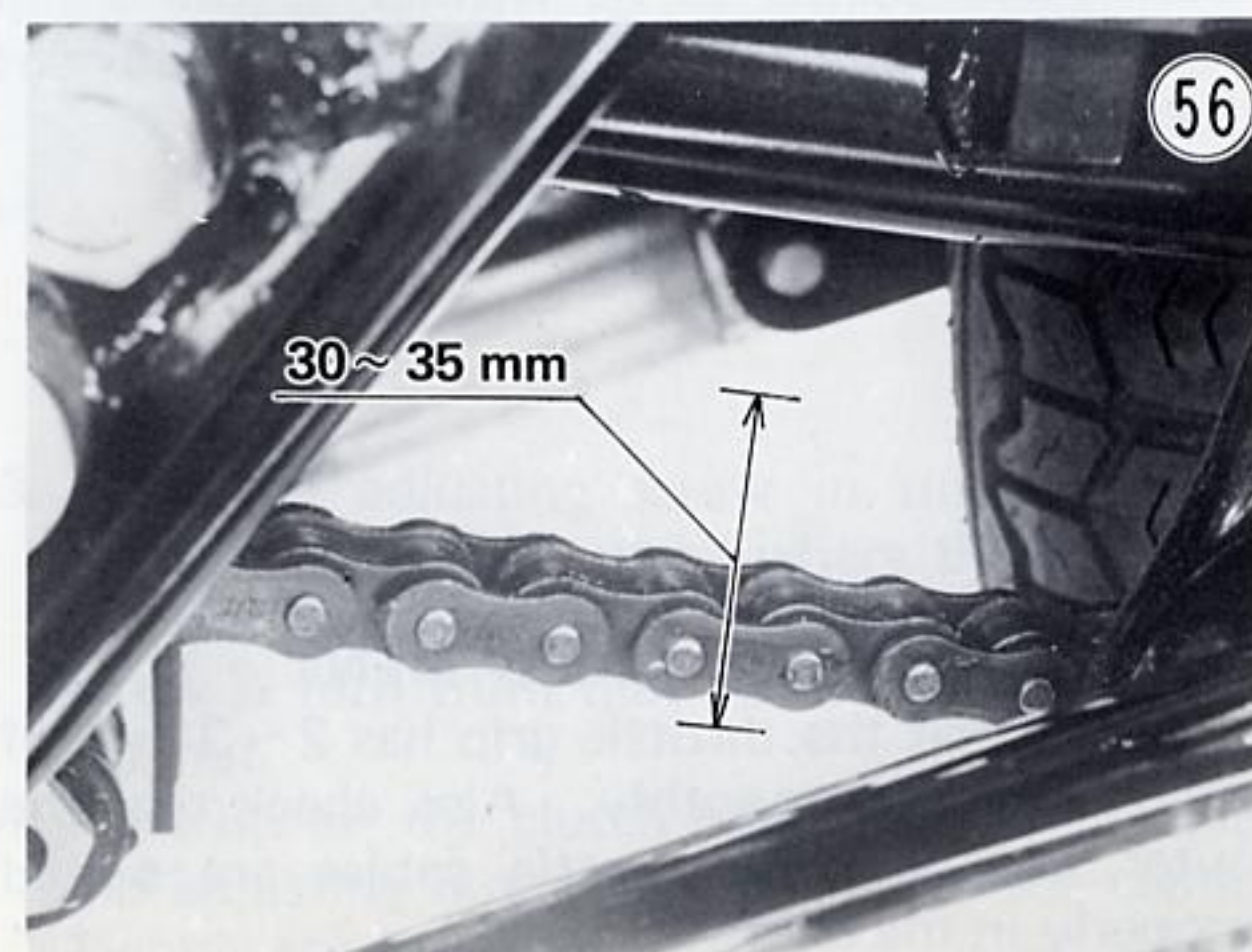



1. Remove the safety clip, and loosen the nut at the rear end of the torque link.

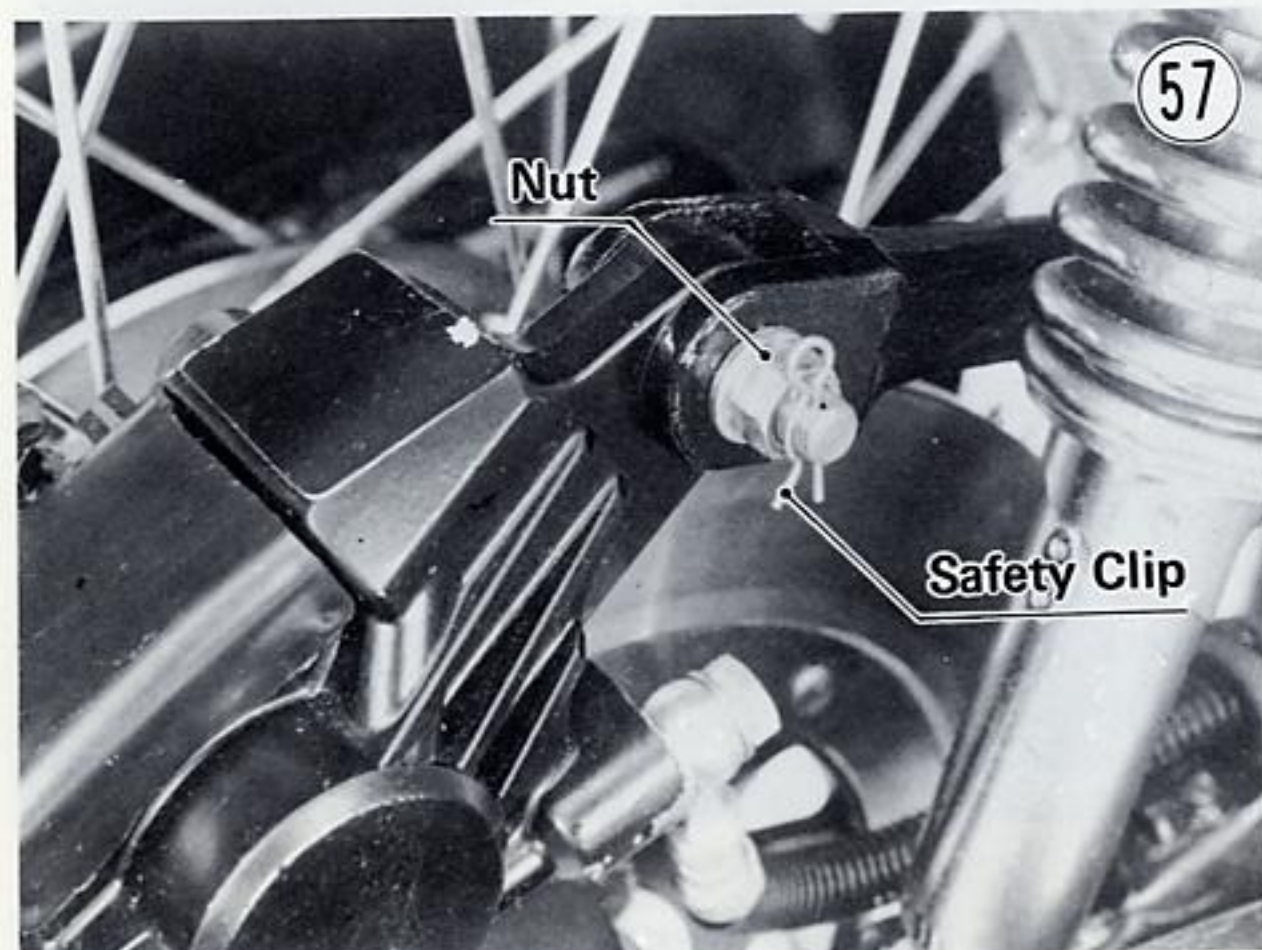

2. Remove the rear axle cotter pin and loosen the axle nut.
3. Loosen the left and right chain adjuster locknuts.
4. If the chain is too tight, back out the left and right chain adjusting bolts, and kick the wheel forward until the chain is too loose.
5. Turn in the left and right chain adjusting bolts evenly until the drive chain has the correct amount of slack. To keep the chain and wheel aligned, the notch on the left chain adjuster should align with the same swing arm mark that the right chain adjuster notch aligns with.

**WARNING** Misalignment of the wheel will result in abnormal wear and may result in an unsafe riding condition.

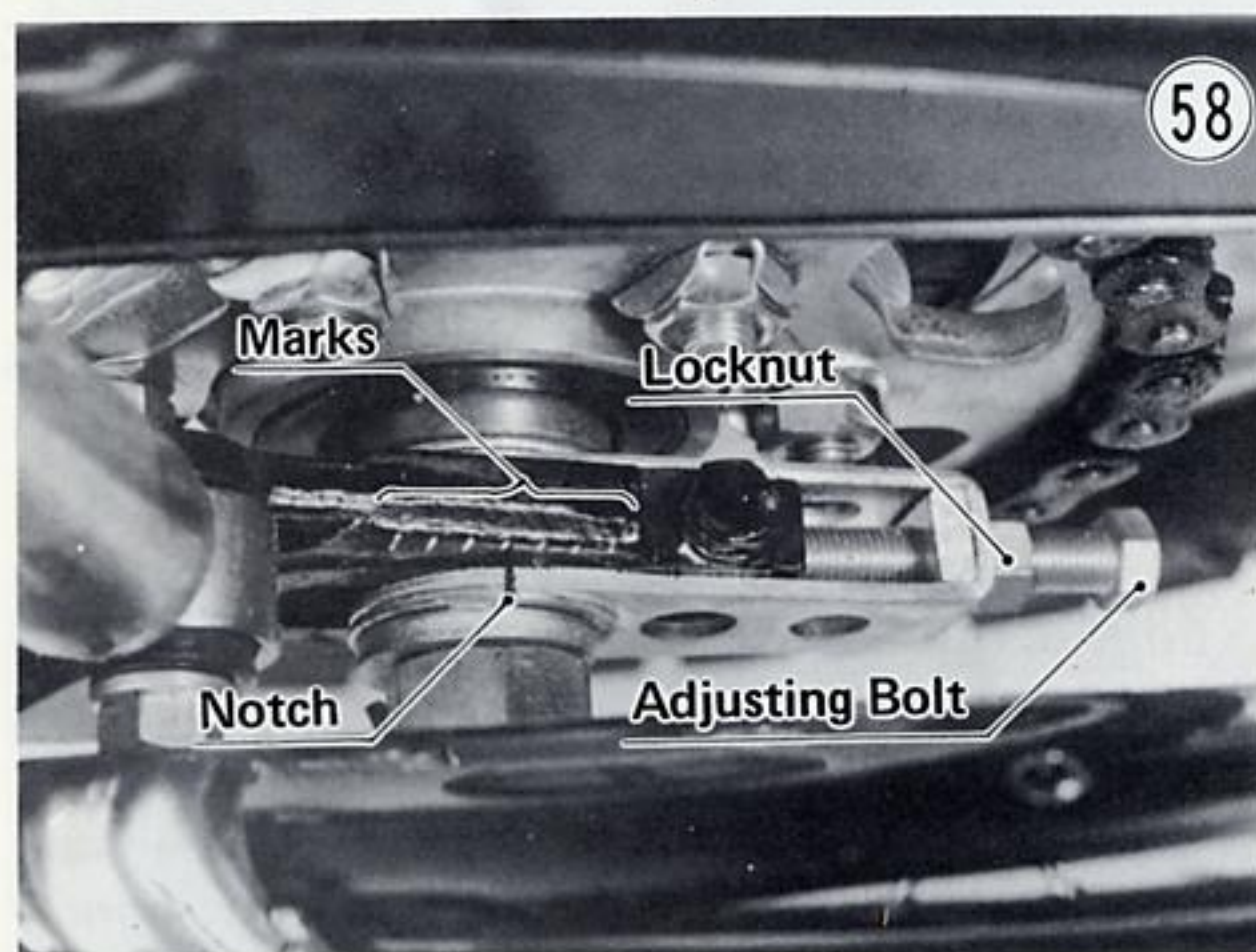

6. Tighten both chain adjuster locknuts securely.
7. Tighten the axle nut with 12 kg-m (87 ft-lbs) of torque.
8. Rotate the wheel, measure the chain play again at the tightest position, and readjust if necessary.

9. Insert a new cotter pin through the axle nut and axle, and spread its ends.

**WARNING** If the axle nut is not securely tightened, and the cotter pin is not installed, an unsafe riding condition may result.

10. Tighten the rear torque link nut with 3.0 kg-m (22 ft-lbs) of torque, and install the safety clip.

### REAR BRAKE ADJUSTMENT

Check that the top of the brake pedal in its rest position is about 20 ~ 30 mm lower than the upper surface of the footpeg.

To adjust pedal position, loosen the locknut and turn the adjusting bolt as required. Tighten the locknut securely.

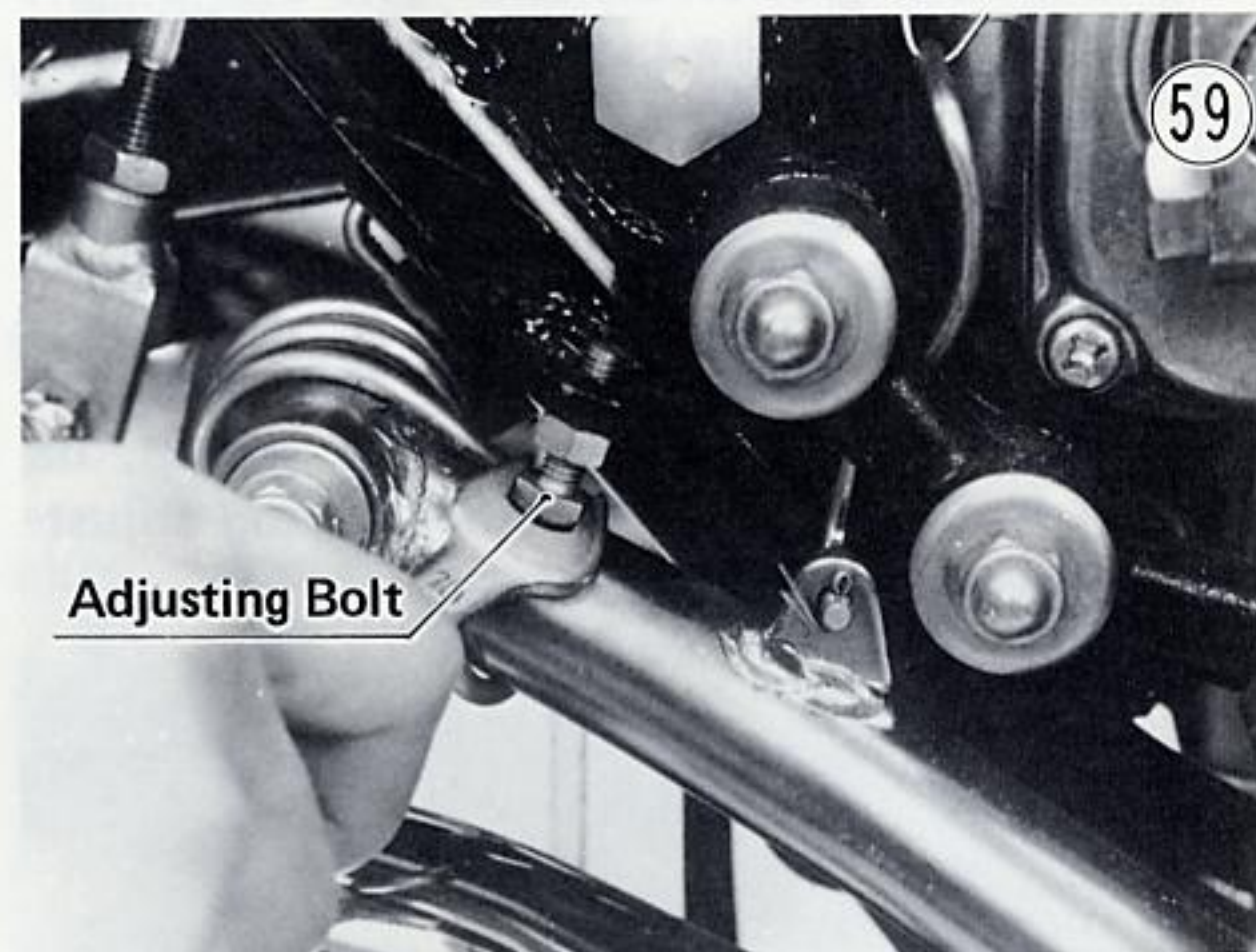

The brake pedal should have 8 ~ 10 mm of free play from the rest position before the push rod contacts the master cylinder piston. To adjust play, loosen the locknut and turn the push rod. Feel for restriction of the push rod's side play to identify when the rod contacts the piston. Tighten the locknut.

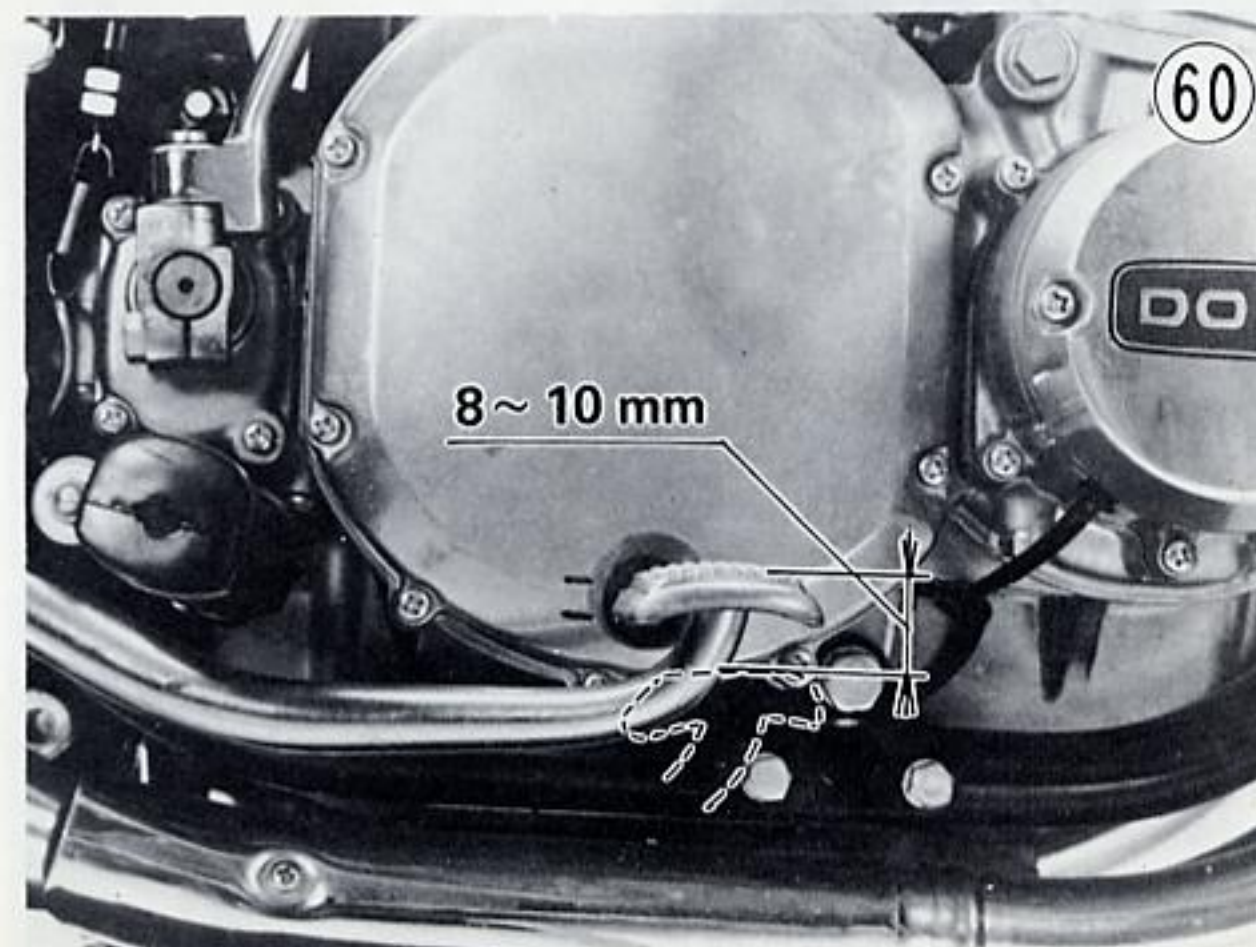



## 16 PREPARATION

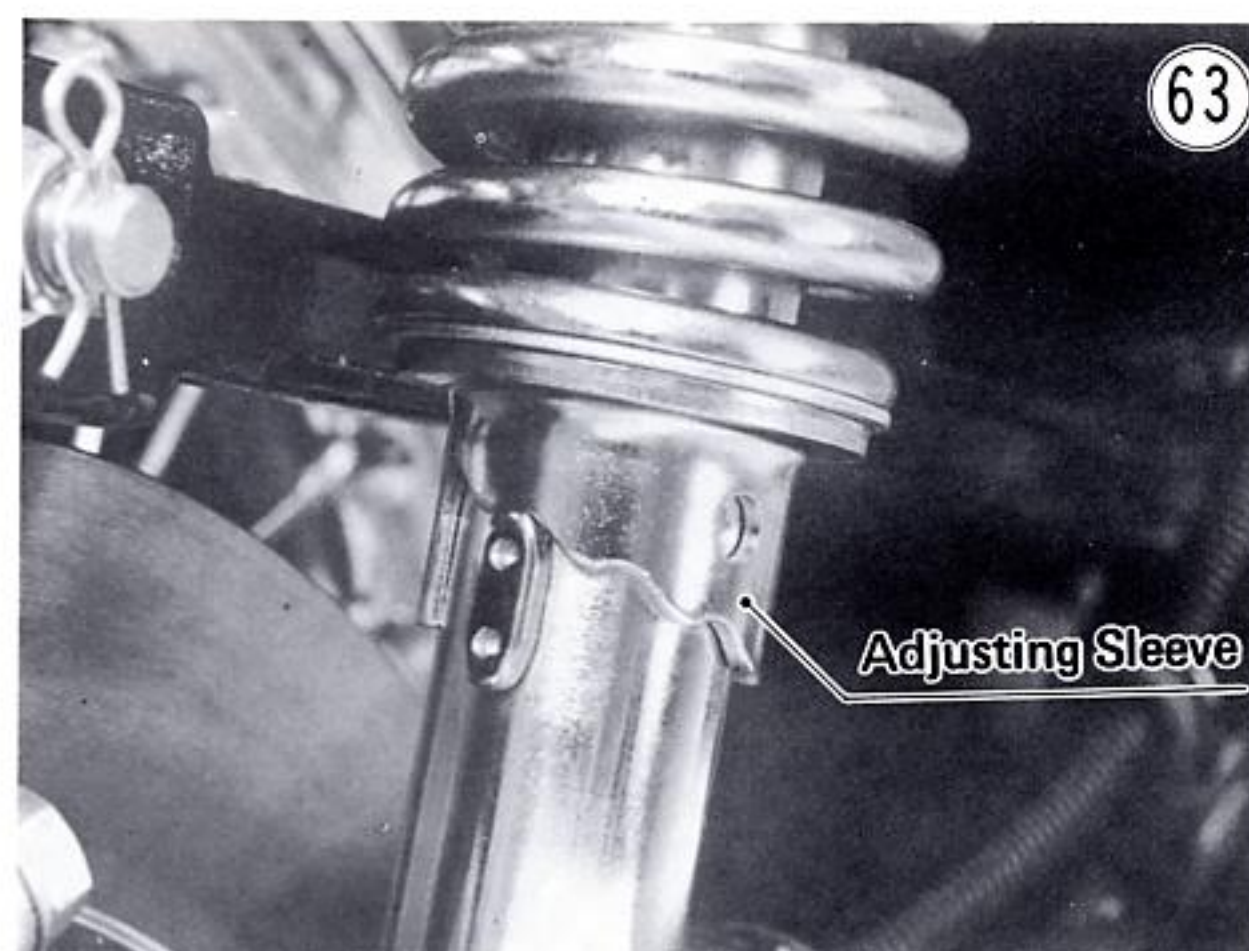
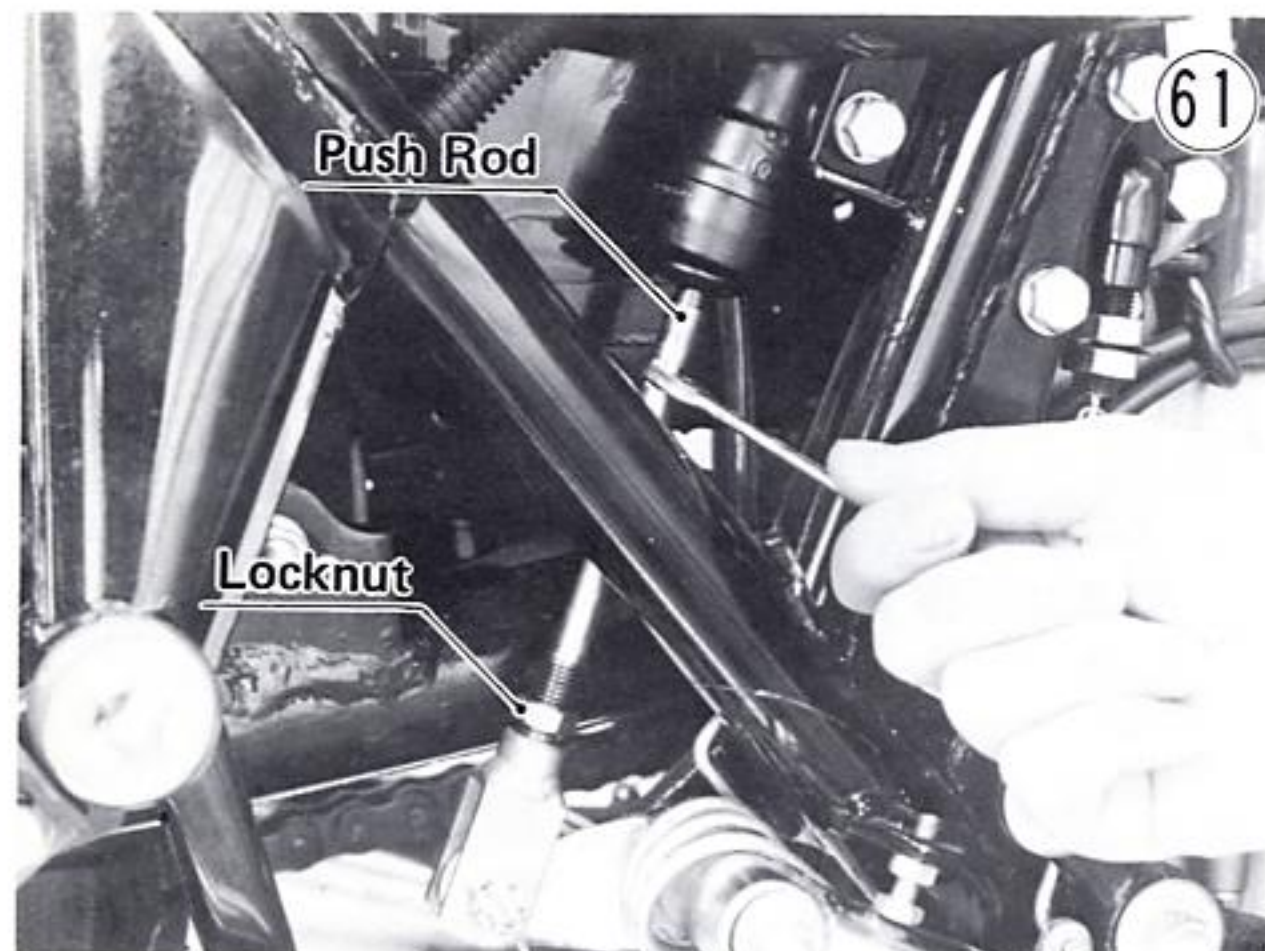

### BRAKE LIGHT SWITCHES

Turn on the ignition switch. The brake light should light when the brake pedal is depressed about 15 mm. If it does not, turn the mounting nuts at the rear brake light switch as required. Check the front brake light switch operation at this time.

**CAUTION** To avoid damaging the electrical connections inside the switch, be sure not to turn the switch body during adjustment.

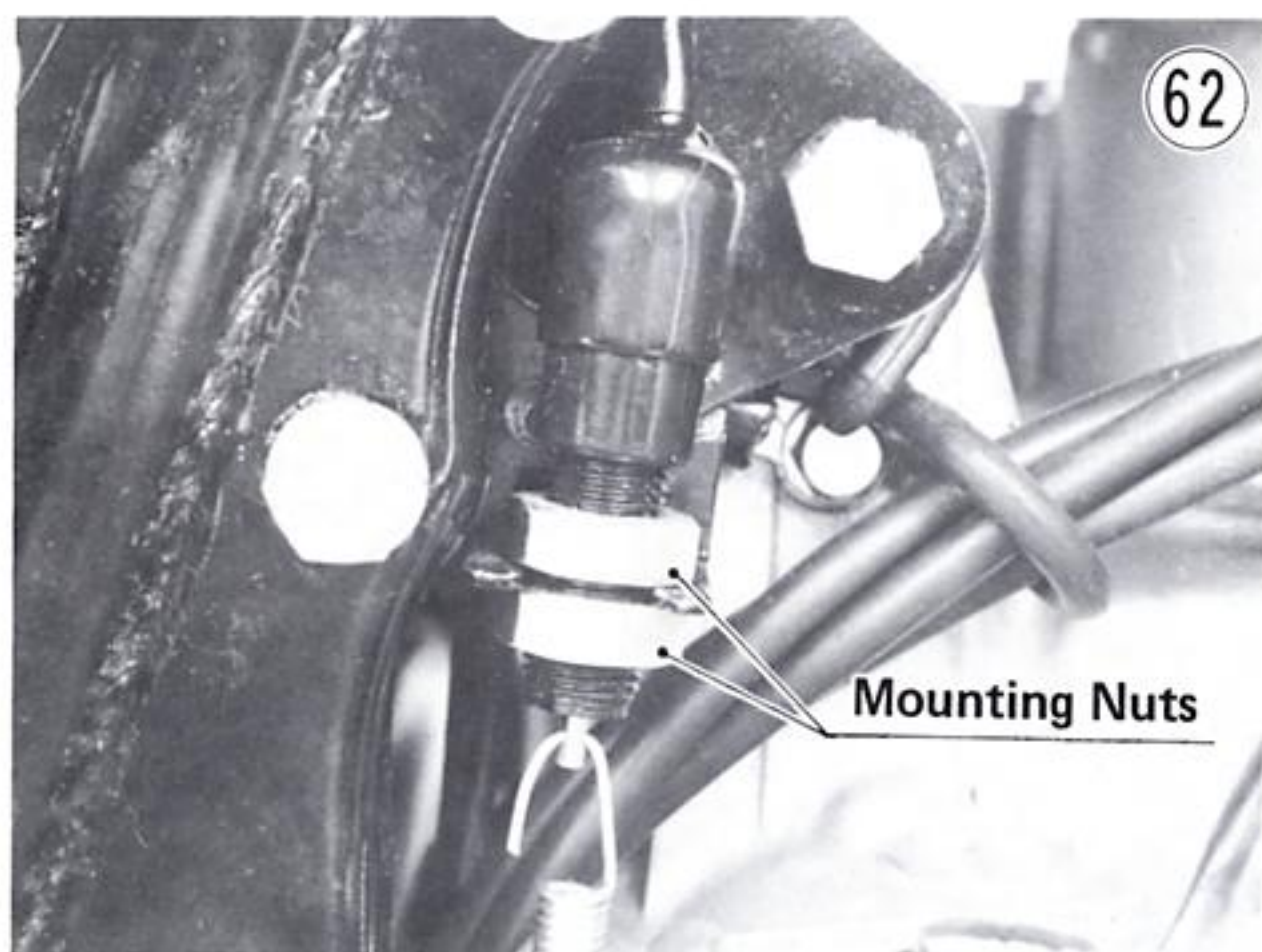

### REAR SHOCK ABSORBERS

Check the adjusting sleeves on the left and right shock absorbers. If necessary, turn the sleeves with a hook wrench for equal spring tension.

**WARNING** If the rear shock absorbers are not adjusted equally, handling may be impaired.

### TIRE PRESSURES

To prevent flat-spotting during shipment, the tires are over-inflated before crating. Adjust the pressure to 2.0 kg/cm<sup>2</sup> (28 psi) in the front and 2.25 kg/cm<sup>2</sup> (32 psi) in the rear.

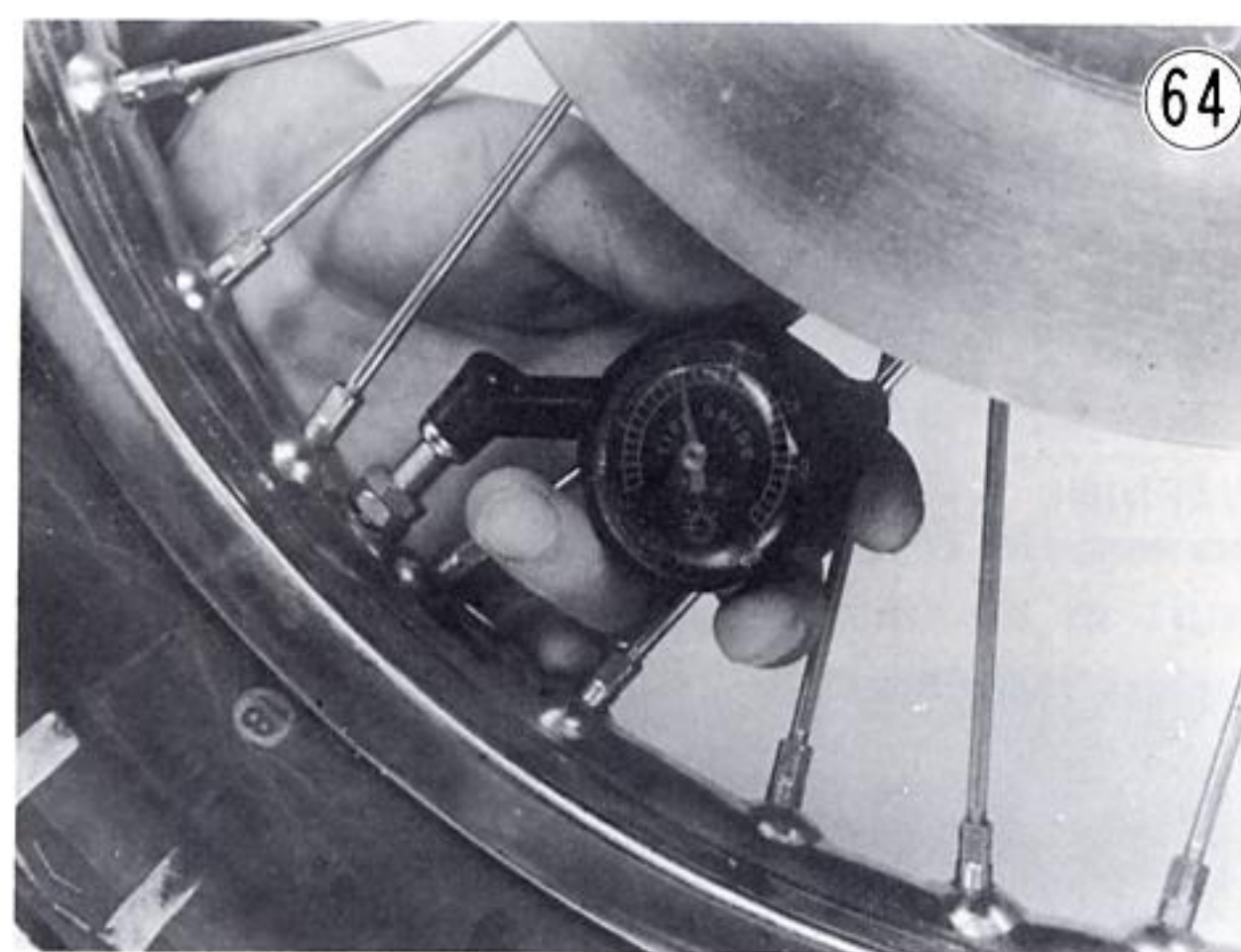

### IGNITION TIMING

#### Point Gap Adjustment

Turn off the ignition switch and the engine stop switch. Remove the contact breaker cover. Turn the crankshaft so that the contact breaker points are at their widest opening. If the gap is not 0.3 ~ 0.4 mm, loosen the contact breaker base screws and use a slot screwdriver on the pry point to set the gap to 0.35 mm. Tighten the base screws securely after adjustment.

Turn the crankshaft until the other set of points is opened, and adjust them.



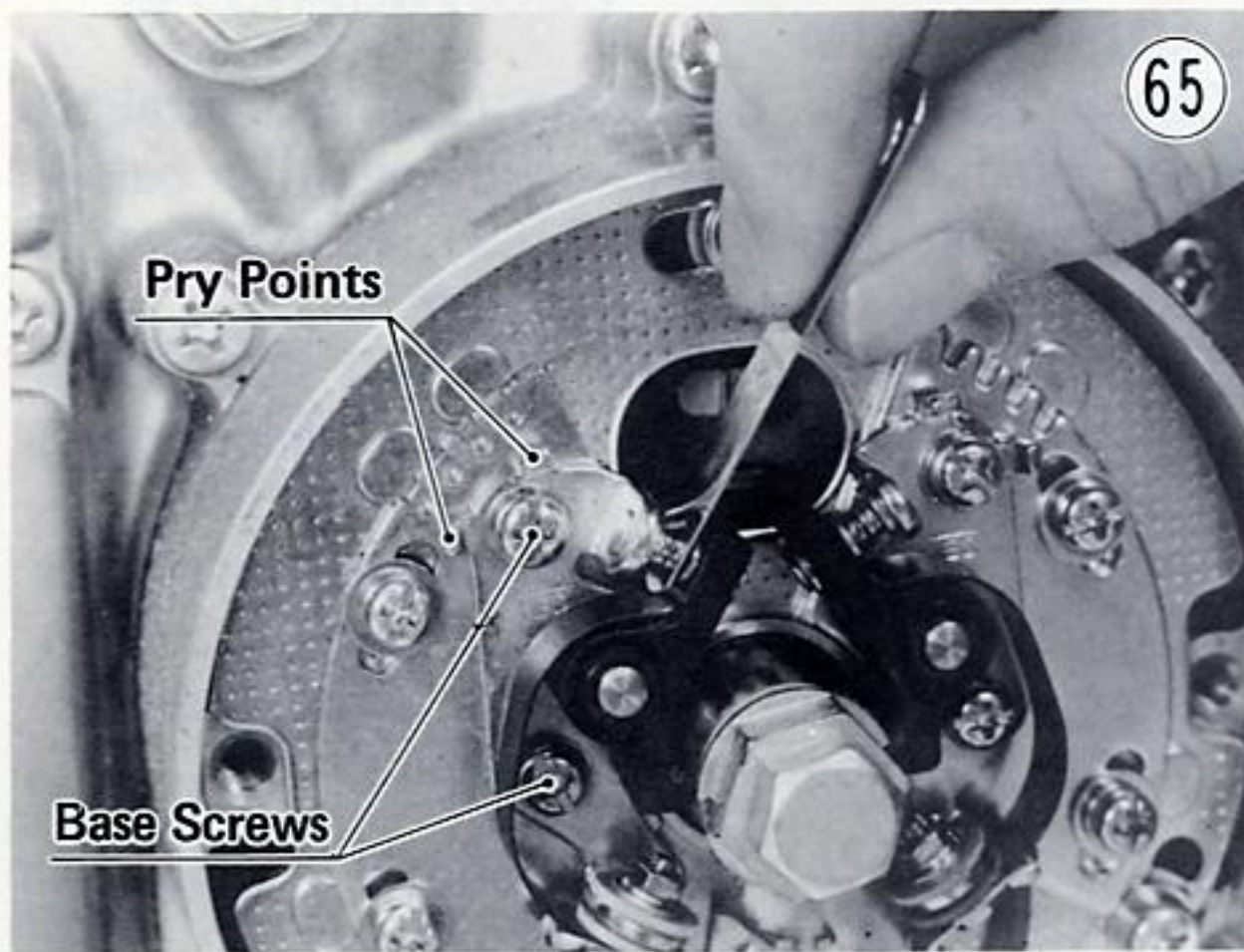

### Ignition Timing Adjustment (Static)

Looking through the inspection window, two sets of ignition timing marks become visible on the timing advancer as the crankshaft is rotated. One set is marked "1 4" and the other set is marked "2 3". Check and adjust static ignition timing using the "F" mark of each set, first for cylinders 1 and 4, then for 2 and 3.

1. Connect a timing tester across the left-hand set of contact breaker points by securing one lead to the contact breaker spring or lead, and the other lead to a suitable ground.
2. Turn the crankshaft clockwise so that the "F" mark at "1 4" on the timing advancer is aligned with the timing mark above the advancer. When using an audible timing tester, there should be a change in tone of the tester at this point, indicating that the points have just opened.
3. If the timing is not correct, loosen the two adjusting plate screws, and use a slot screwdriver in the pry points to adjust the timing. Tighten the screws securely and recheck the timing.
4. Move the timing tester leads to the right-hand set of points. Repeat the last two steps using the other "F" mark.

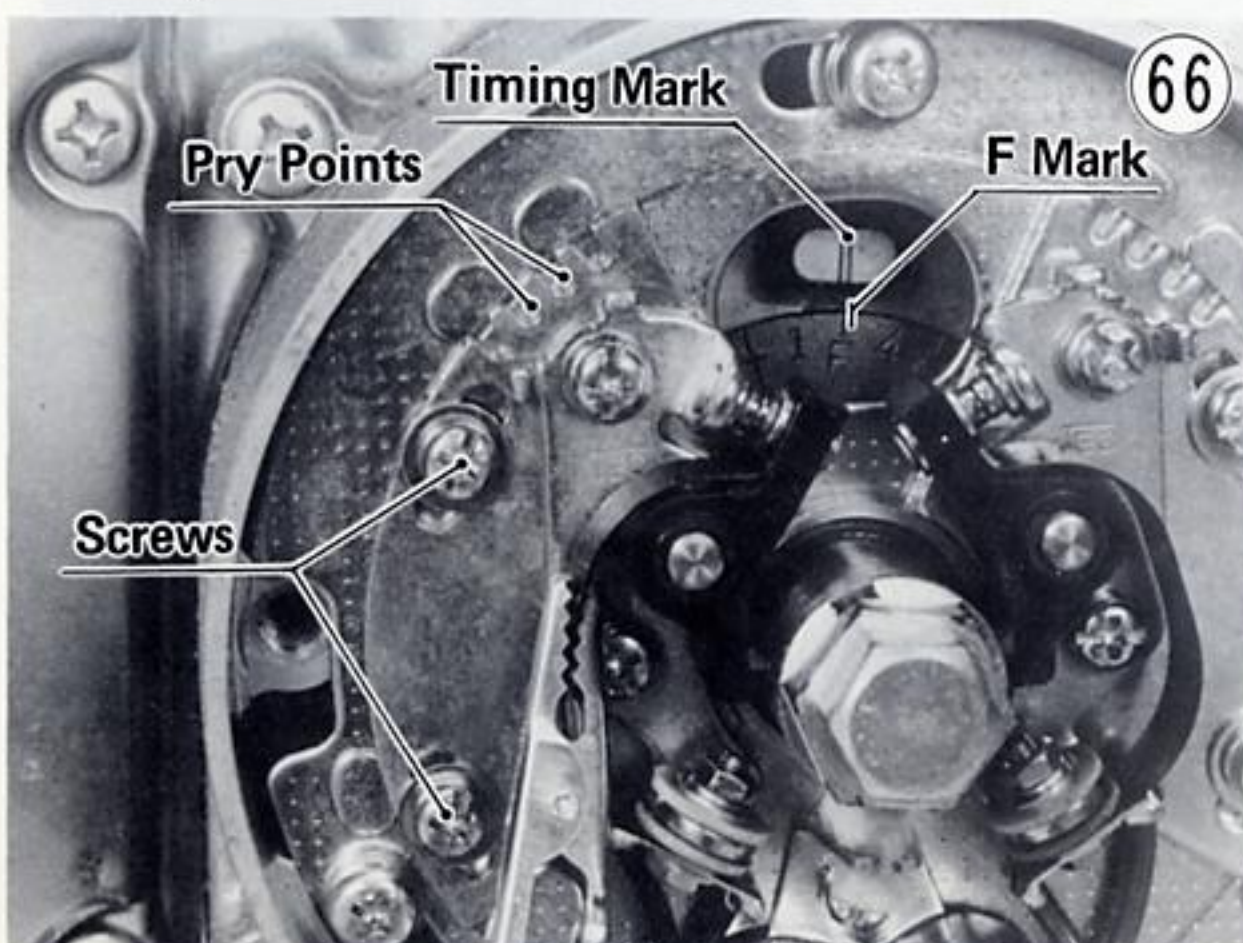

### Ignition Timing Adjustment (Dynamic)

1. Connect the strobe light lead to the spark plug lead numbered "4" in order to check the ignition timing for the "1" and "4" cylinders under operating condition.
2. Turn on the ignition switch and engine stop switch. Start the engine, and direct the strobe light at the timing marks.
3. At idle the "F" mark on the timing advancer must be aligned with the timing mark above the advancer for correct low rpm ignition timing. If the timing is not correct, adjust it by moving the adjusting plate (the left side one for the "1" and "4" cylinders).
4. At 2,350 rpm or higher the advanced timing mark (the vertical line on the right side of the "F" mark) must be aligned with the timing mark above the advancer for correct high rpm ignition timing. If the timing is not correct, examine the timing advancer mechanism for binding.
5. Next, move the strobe light lead to the spark plug lead numbered "3", and check the ignition timing for the "2" and "3" cylinders. Adjust the right side plate if necessary.
6. Install the contact breaker cover.

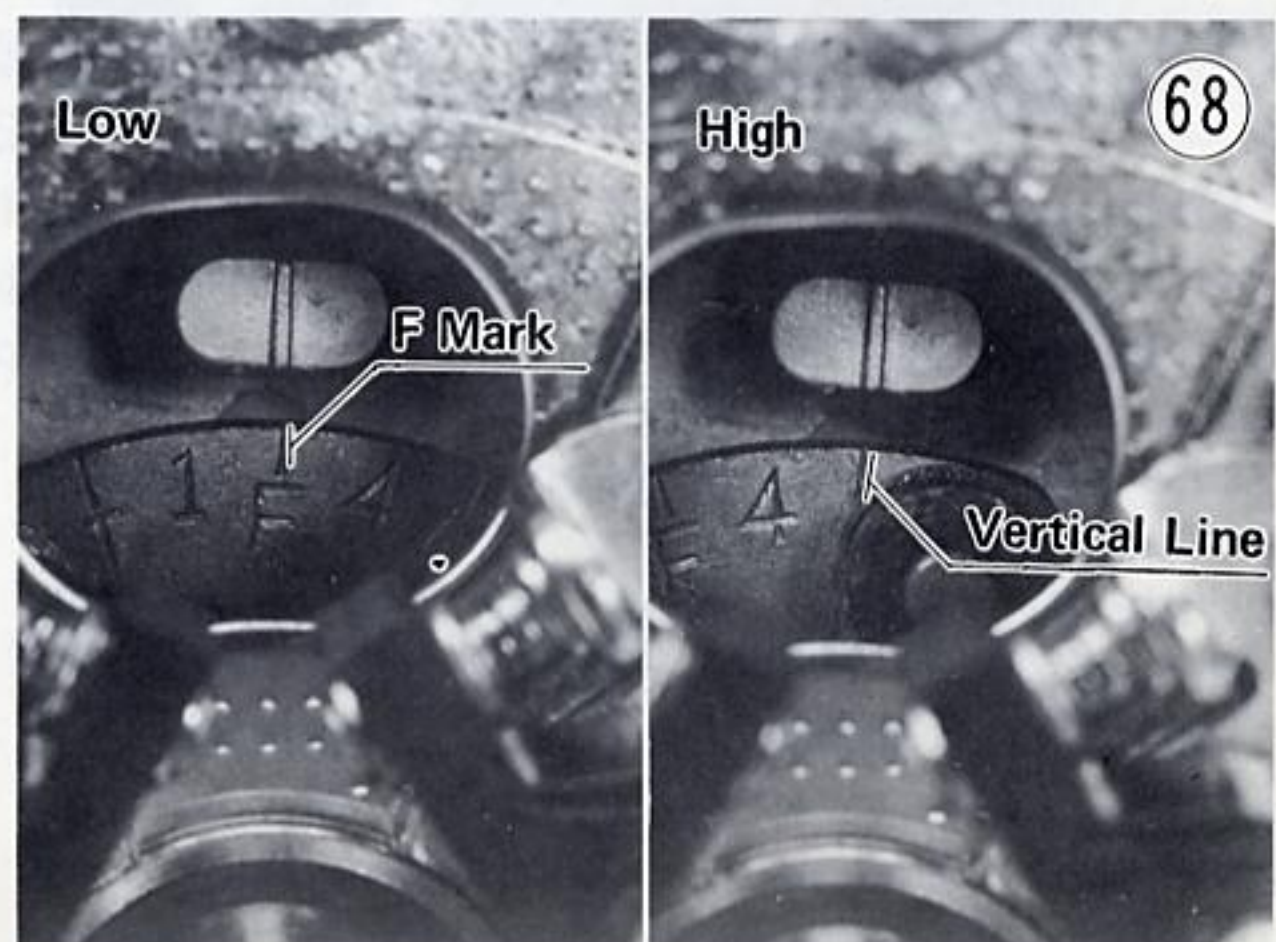



## 18 PREPARATION

### IDLING ADJUSTMENT

1. Start the engine and warm it up for five minutes.
2. Back out the idling screw until the engine is at the lowest smooth rpm.
3. Adjust the pilot screw of each carburetor, one at a time, to obtain highest idle rpm. This pilot screw adjustment will be within  $\frac{1}{8}$  turn in or out from the specified pilot screw setting.

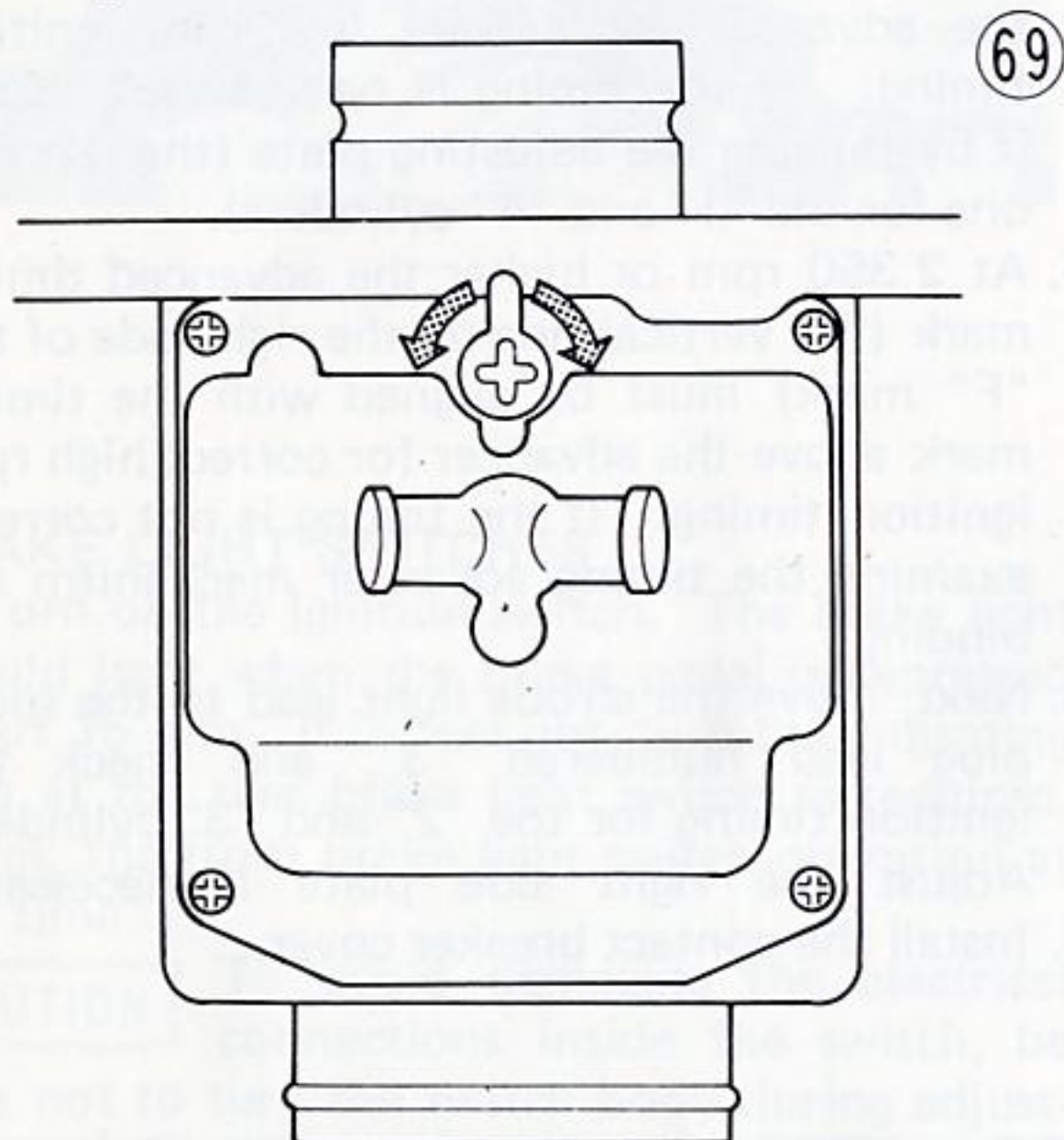

4. Adjust idling speed to 950 ~ 1,050 rpm by turning the idling screw.

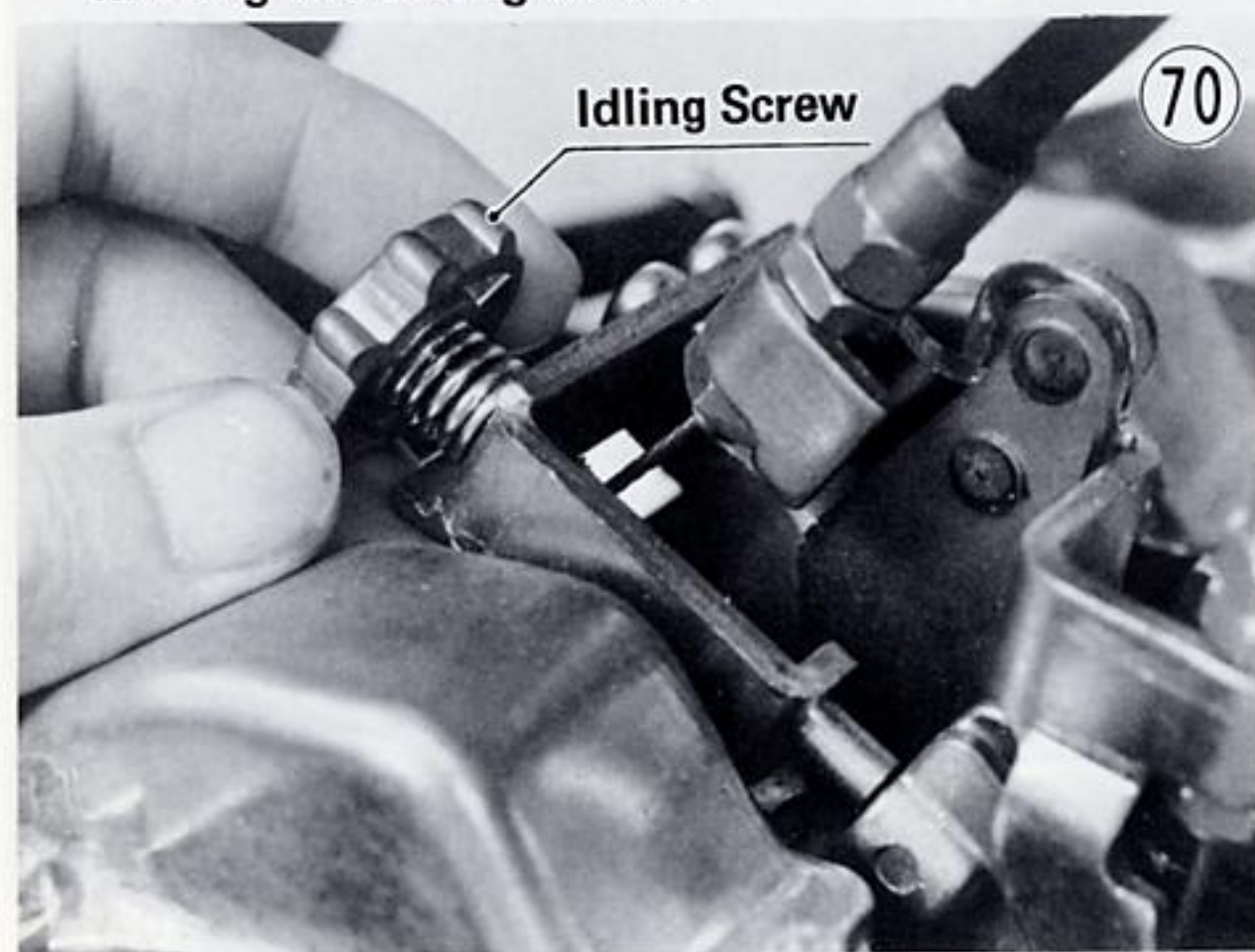

5. Check to see if engine rpm rises when the pilot screw positions are altered. If it rises, repeat the last three steps.
6. Turn the throttle grip a few times to make sure that the idling speed does not change. Readjust if necessary.
7. With the engine idling, turn the handlebar to each side. If handlebar movement changes idling speed, check throttle cable routing.

**NOTE:** If fine adjustment of carburetor synchronization is necessary, use the vacuum gauges following the procedure in the Shop Manual.

### HEADLIGHT AIM

Check that the headlight is aimed straight ahead, with the brightest spot slightly below horizontal on high beam. If adjustment is necessary, carry out the following.

1. Turn the small screw on the right side of the headlight rim in or out until the beam points straight ahead.
2. Loosen the nuts securing the front turn signals to the headlight housing. Move the headlight up or down until the vertical aim is correct. Tighten the mounting nuts securely.

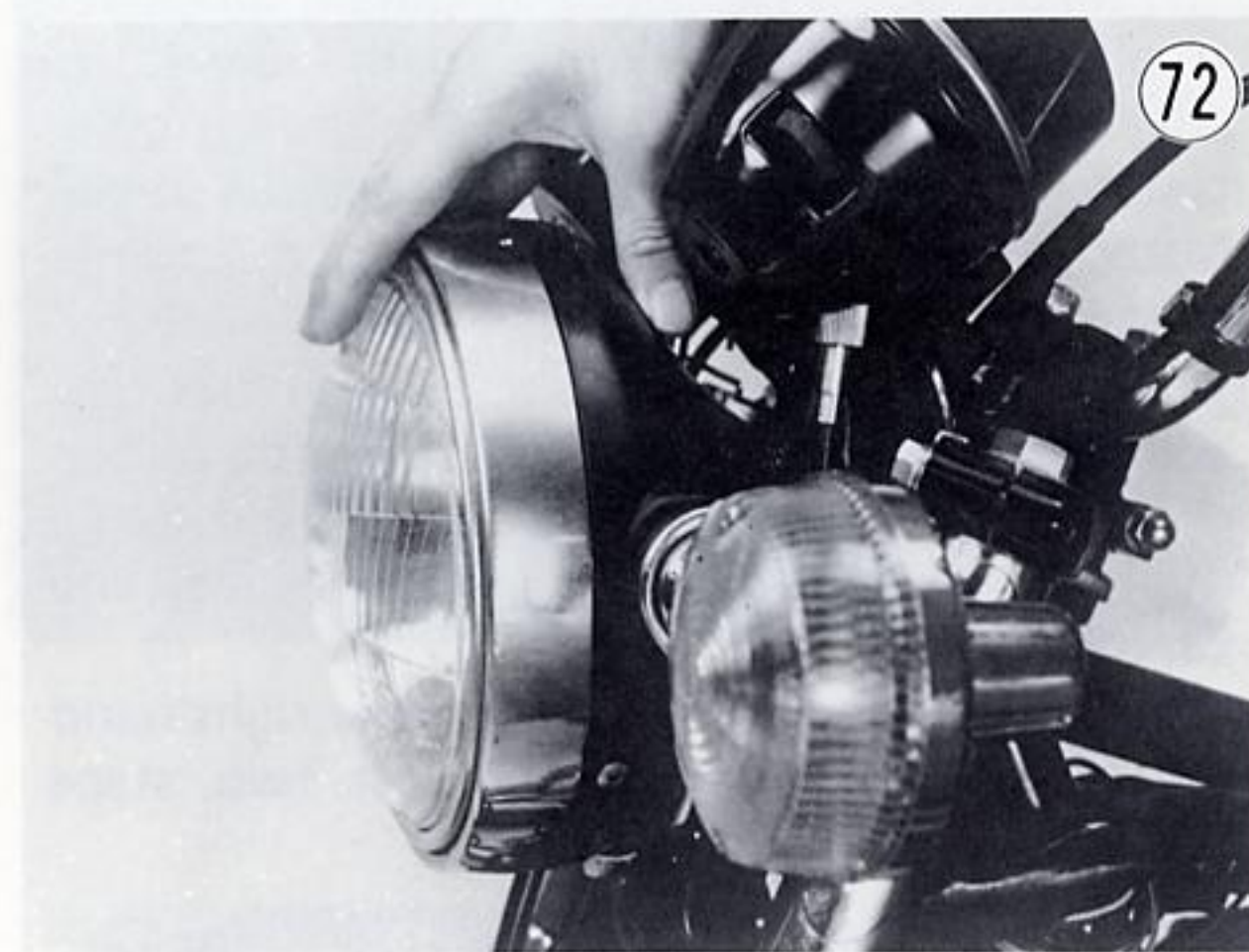
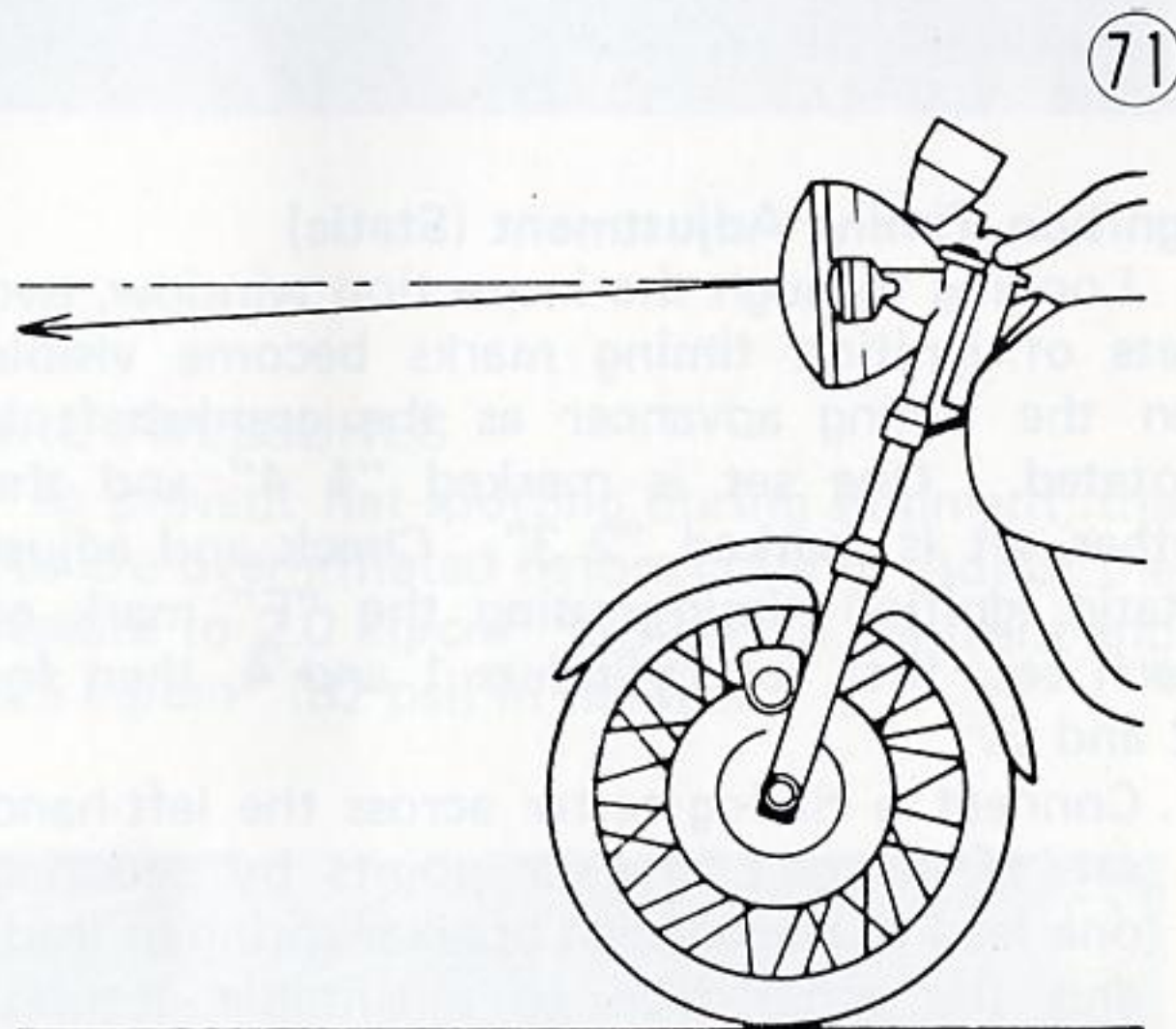

### FASTENER CHECK

Check all fasteners shown on page 20 and tighten as required.

### TEST RIDE

Complete the test ride checklist on page 23.

**PREPARATION COMPLETE**



## SPECIFICATIONS

# Appendix

## ENGINE

Type	DOHC 4 stroke, 4 cylinder, air-cooled		
Bore and stroke	70 x 66 mm (2.76 x 2.60 inch)		
Displacement	1,015 cc (61.92 cu in)		
Compression ratio	8.7:1		
Maximum horsepower	83 HP/8,000 rpm		
Maximum torque	8.1 kg-m/6,500 rpm (58.7 ft-lbs/6,500 rpm)		
Valve timing			
	Intake	Open	30° BTDC
		Close	70° ABDC
		Duration	280°
	Exhaust	Open	70° BBDC
		Close	30° ATDC
		Duration	280°
Lubrication system	Forced lubrication (wet sump)		
Starting system	Electric starter & kick		
Ignition system	Battery and coil		
Ignition timing	20° BTDC/1,500 rpm ~ 40° BTDC/2,350 rpm		
Spark Plugs	NGK B8ES		

## CARBURETOR

Manufacturer, Size	Mikuni VM26SS x 4
Main jet	107.5 R
Jet needle	5CN8-3
Needle jet	O-8
Throttle valve	1.5
Pilot jet	17.5
Pilot screw	1¼ ± 1/8
Service fuel level	2.5~4.5 mm
Identification	299

## LUBRICATION

Engine oil type	SAE 10W40
Engine oil quantity	3.7 ℓ
	3.0 ℓ (without filter change)
Front fork oil type	SAE 10W
Front fork oil quantity (each fork)	170~178 cc
Front fork oil level	426 mm (from top)
Chain oil	SAE 90

Specifications subject to change without notice, and may not apply to every country.



**CHECK AND TIGHTEN**

Check the tightness of the bolts and nuts shown below, and retighten if required. Also, check the (☆) marked items for the presence of a cotter pin or safety clip.

ITEM	DESCRIPTION	TOOL SIZE	REMARKS
1	Bleed Valve	10 mm	0.7~1.0 kg-m (61~87 in-lbs)
2	☆ Torque Link Nuts (2)	14 mm	2.6~3.5 kg-m (19.0~25 ft-lbs)
3	Rear Shock Absorber Nuts (2)	17 mm	2.6~3.5 kg-m (19.0~25 ft-lbs)
4	Brake Hose Banjo Bolt	14 mm	2.9~3.1 kg-m (21~22 ft-lbs)
5	Cylinder Head Cover Bolts (16)	10 mm	1.1~1.3 kg-m (95~113 in-lbs)
6	Steering Stem Head Clamp Bolt	13 mm	1.6~2.2 kg-m (11.5~16.0 ft-lbs)
7	Steering Stem Head Bolt	27 mm	4~5 kg-m (29~36 ft-lbs)
8	Brake Hose Banjo Bolt	14 mm	2.9~3.1 kg-m (21~22 ft-lbs)
9	Front Fork Lower Clamp Bolts (2)	17 mm	3.4~4.6 kg-m (25~33 ft-lbs)
10	Front Brake Light Switch	27 mm	2.6~3.0 kg-m (19.0~22 ft-lbs)
11	Front Axle Nuts (2)	27 mm	7~9 kg-m (51~65 ft-lbs)
12	Caliper Bolts (2)	8 mm Allen	2.8~3.2 kg-m (20~23 ft-lbs)
13	Brake Hose Banjo Bolt	14 mm	2.9~3.1 kg-m (21~22 ft-lbs)
14	Tire Pressure — Rear		2.25 kg/cm <sup>2</sup> (32 psi)
15	Brake Pedal Pivot Nut	13 mm	1.6~2.2 kg-m (11.5~16.0 ft-lbs)
16	Footpeg Mounting Nuts (4)	13 mm	
17	Kick Pedal Bolt	14 mm	
18	Engine Bracket Nuts (8)	17 mm	2.0~2.8 kg-m (14.5~20.0 ft-lbs)
19	Exhaust Pipe Holder Nuts (8)	12 mm	
20	Tire Pressure — Front		2.0 kg/cm <sup>2</sup> (28 psi)
21	Front Axle Clamp Nuts (4)	13 mm	1.6~2.2 kg-m (11.5~16.0 ft-lbs)
22	Bleed Valve (2)	10 mm	0.7~1.0 kg-m (61~87 in-lbs)
23	Brake Pipe Banjo Bolts (4)	10 mm	1.7~1.9 kg-m (12.0~13.5 ft-lbs)
24	Brake Hose Banjo Bolt (2)	14 mm	2.9~3.1 kg-m (21~22 ft-lbs)
25	Front Fork Upper Clamp Bolts (2)	13 mm	1.6~2.2 kg-m (11.5~16.0 ft-lbs)
26	Lever Pivot Nuts (2)	10 mm	
27	Handlebar Clamp Bolts (4)	13 mm	1.6~2.2 kg-m (11.5~16.0 ft-lbs)
28	Steering Stem Nut		
29	Cylinder Head Nuts (12)	14 mm	3.7~4.3 kg-m (27~31 ft-lbs)
30	Fuel Tap Nut	26 mm	
31	Swing Arm Pivot Nut	24 mm	8~12 kg-m (58~87 ft-lbs)
32	Rear Shock Absorber Bolts (2)	14 mm	2.6~3.5 kg-m (19.0~25 ft-lbs)
33	☆ Rear Axle Nut	27 mm	10~14 kg-m (72~101 ft-lbs)
34	Caliper Bolts (4)	14 mm	2.4~2.8 kg-m (17.5~20 ft-lbs)
35	Caliper Bracket Bolts (4)	14 mm	3.4~4.6 kg-m (25~33 ft-lbs)
36	Brake Disc Bolts (4)	14 mm	3.4~4.6 kg-m (25~33 ft-lbs)
37	Spoke Nipples		0.2~0.4 kg-m (17~35 in-lbs)
38	Engine Mounting Nuts (3)	17 mm	3.4~4.6 kg-m (25~33 ft-lbs)
39	Engine Mounting Bolts (2)	17 mm	3.4~4.6 kg-m (25~33 ft-lbs)
40	Shift Pedal Bolt	10 mm	
41	☆ Footpeg Pivot		
42	Rear Sprocket Nuts (6)	17 mm	3.4~4.6 kg-m (25~33 ft-lbs)
43	Bead Protectors (3)	12 mm	



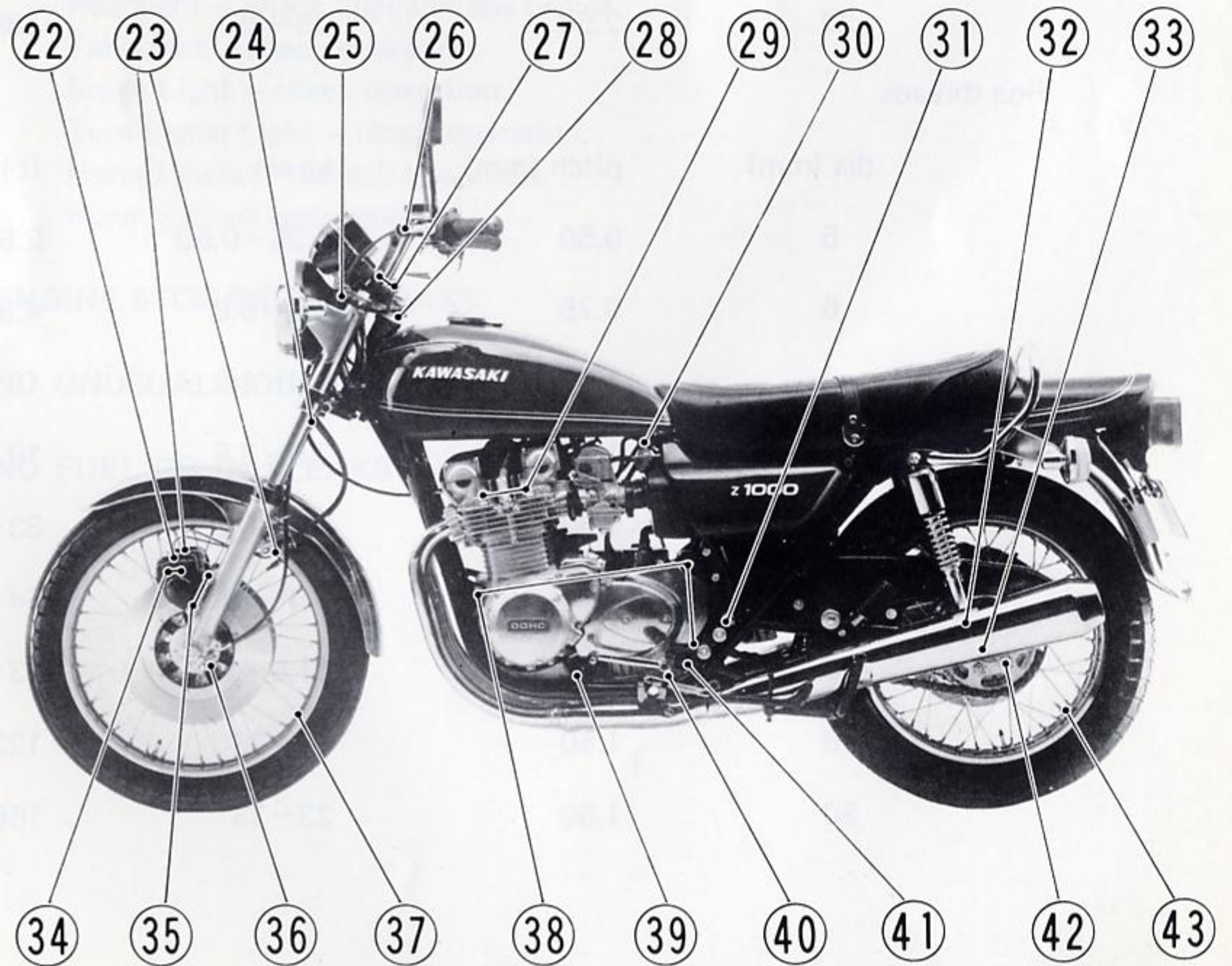
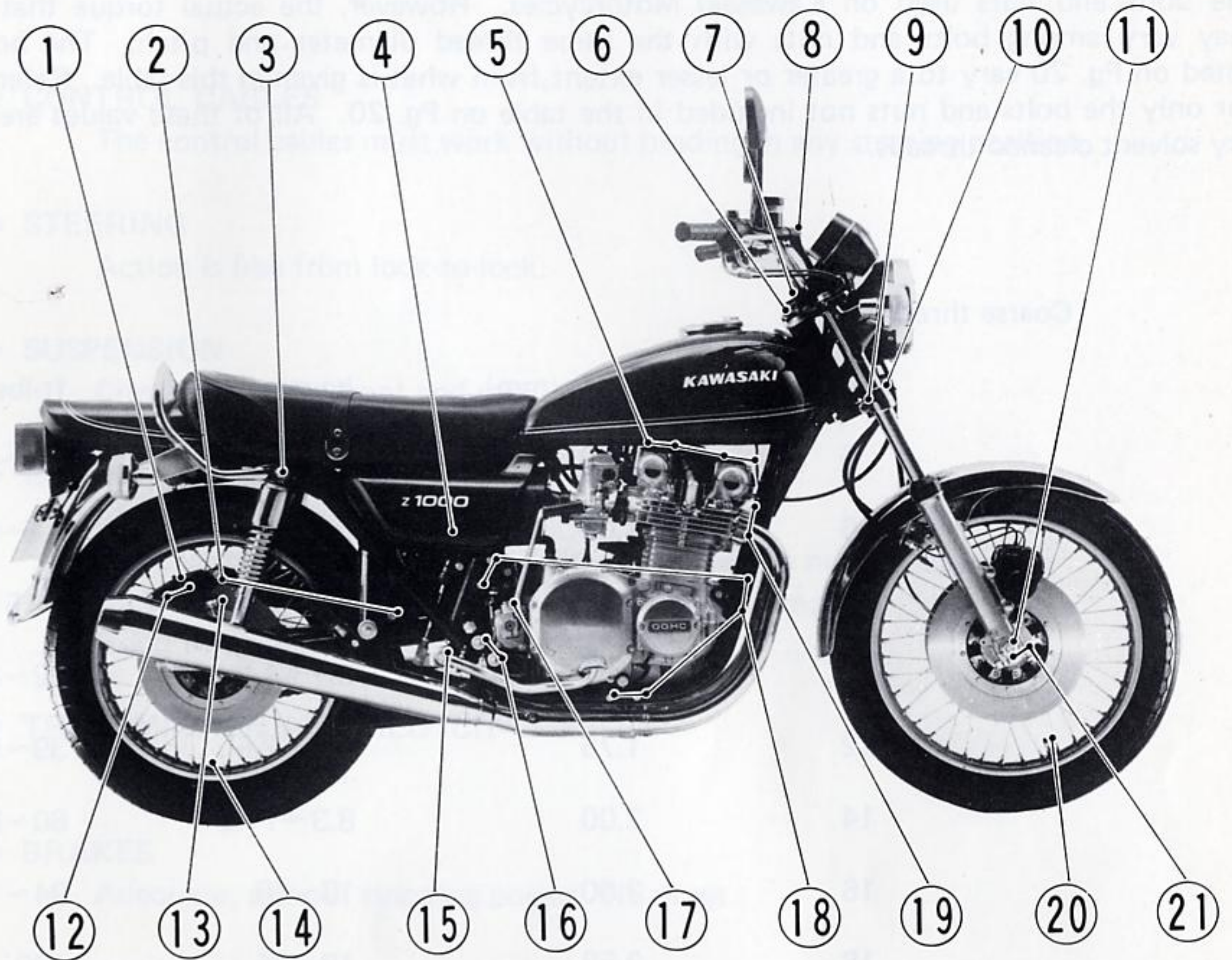



## 22 APPENDIX

The table below, relating tightening torque to thread diameter and pitch, lists the basic torque for the bolts and nuts used on Kawasaki Motorcycles. However, the actual torque that is necessary may vary among bolts and nuts with the same thread diameter and pitch. The bolts and nuts listed on Pg. 20 vary to a greater or lesser extent from what is given in this table. Refer to this table for only the bolts and nuts not included in the table on Pg. 20. All of these values are for use with dry solvent cleaned threads.

### Coarse threads

dia (mm)	Pitch (mm)	kg-m	ft-lbs
5	0.90	0.35~0.50	2.5~3.5
6	1.00	0.6~0.9	4.5~6.5
8	1.25	1.6~2.2	11.5~16.0
10	1.50	3.1~4.2	22~30
12	1.75	5.4~7.5	39~54
14	2.00	8.3~11.5	60~83
16	2.00	13~18	94~130
18	2.50	18~25	130~181
20	2.50	26~35	188~253

### Fine threads

dia (mm)	pitch (mm)	kg-m	ft-lbs
5	0.50	0.35~0.50	2.5~3.5
6	0.75	0.6~0.8	4.5~5.5
8	1.00	1.4~1.9	10.0~13.5
10	1.25	2.6~3.5	19.0~25
12	1.50	4.5~6.2	33~45
14	1.50	7.4~10.2	54~74
16	1.50	11.5~16	83~116
18	1.50	17~23	123~166
20	1.50	23~33	166~239



**TEST RIDE THE MOTORCYCLE**

- **CONTROL CABLES**

The control cables must work without binding in any steering position.

- **STEERING**

Action is free from lock-to-lock.

- **SUSPENSION**

Check operation front and rear.

- **ENGINE**

Electric starter works.

Electric starter does not work if the clutch lever is not pulled in.

Kick starter works properly and engine starts promptly.

Good throttle response and return.

- **TRANSMISSION AND CLUTCH**

Smooth operation.

- **BRAKES**

Adequate, smooth stopping power. No drags.

- **ELECTRICAL SYSTEM**

Headlight – check high and low beams.

Tail Light – check operation.

Brake Light – check operation.

Turn Signal Light – check operation.

Hazard Switch – check operation.

Horn – check operation.

- **ENGINE STOP SWITCH WORKS**

- **NO UNUSUAL NOISES**

- **NO FUEL OR OIL LEAKS**









**KAWASAKI**  
HEAVY INDUSTRIES, LTD.  
ENGINE AND MOTORCYCLE GROUP

Part No. 99931-538-01

Printed in Japan